

COMBUSTION: A COMPLEX SCIENCE AND AN ANCIENT BUT IMMATURE TECHNOLOGY

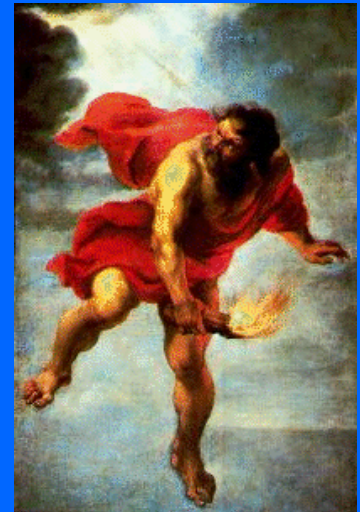

WILLIAM A. SIRIGNANO
MECHANICAL AND AEROSPACE ENGINEERING
UNIVERSITY OF CALIFORNIA, IRVINE

PROMETHEUS GOD OF FIRE



KAGUTSUCHI (HO-MASUBI)



AGNI



“THE CREATURES OF PROMETHEUS”
BEETHOVEN’S ONLY BALLET

FUELS AND OXIDIZERS

Solid Fuels – Wood (and other biomaterials) , Coal, Plastics, Metals

Liquid Fuels – Hydrocarbons, Liquid Hydrogen

Gaseous Fuels – Methane, Propane, Hydrogen

Solid Oxidizer – Ammonium Perchlorate (NH_4ClO_4)

Liquid Oxidizer - Liquid Oxygen

Gaseous Oxidizer – Air, Oxygen, Fluorine

Solids and Liquids can occur in bulk or as particles (droplets or dust).

MEASURES

➤ PERFORMANCE

- * Fuel consumption rate / Power (Thrust)
- * Miles / Gallon of fuel
- * Power (Thrust) / Air flow rate
- * Power (Thrust) / Engine weight

➤ EMISSIONS

- * Parts per million of pollutant

➤ ECONOMY

- * Fuel consumption rate / Power (Thrust)
- * Capital costs: research, development, and
manufacture



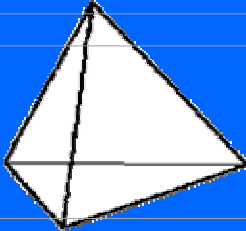
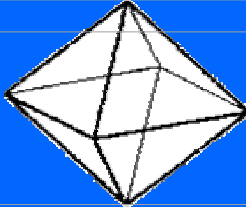
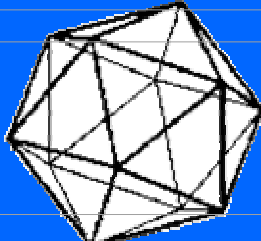
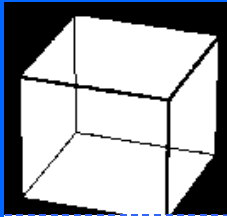



THE FOUR ELEMENTS

Empedocles	Fire	Air	Water	Earth
Plato: Platonic Solids with Triangles				
Aristotle	hot & dry	hot & wet	cold & wet	cold & dry

- > The Ancient Chinese, Hindu, and Buddhists each had three to five elements; fire was always one of them.
- > Neither Plato or Aristotle were exactly on the mark but the world unfortunately went down the “touchy, feely” path of Aristotle rather than the mathematical path of Plato.

ALCHEMY

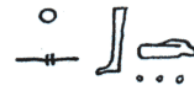

	<i>nub</i>	Gold.
	<i>asem</i>	Electrum.
	<i>hat</i>	Silver.
	<i>χomt</i>	Copper.
	<i>men</i>	Iron.
	<i>teht</i>	Lead.
	<i>chesbet</i>	Blue Stone, or Enamel, or Sapphire.

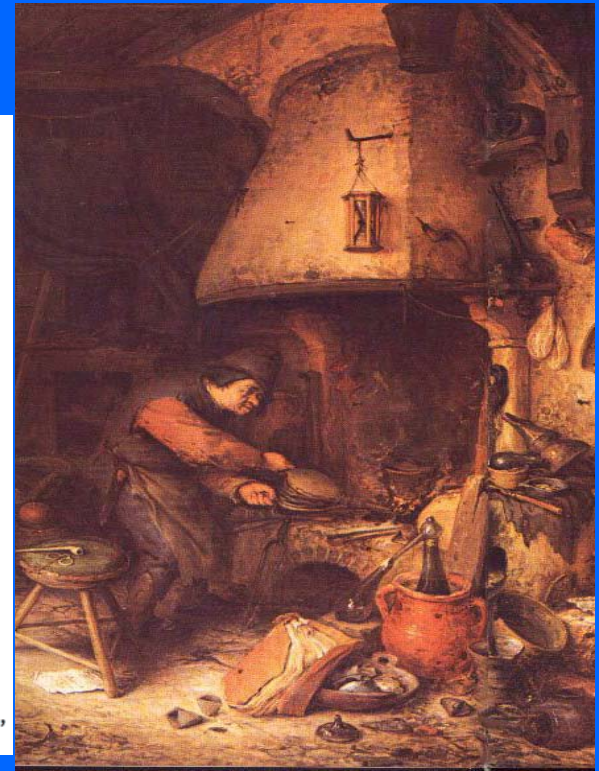

- > Began in Alexandria in early A.D. period.
- > Alchemists can broadly include magicians, mystics, and fakers. We will emphasize early chemists, biochemists, and metallurgists.
- > Many pursued Aristotle's Theory of Transmutation, e.g. attempt to convert lead to gold.
- > Fire was the "element of transformation."
- > Fire was also the first chemical reaction that man could produce and control.

IMPORTANT 18TH - CENTURY DEVELOPMENTS

- > Georg Ernst Stahl, early 1700s -- All combustible materials give off “phlogiston” when burning; air absorbs phlogiston.
- > Joseph Black, 1750s -- Identified carbon dioxide.
- > Henry Cavendish, 1760s -- Identified hydrogen and thought it was pure phlogiston.
- > Carl Scheele and Joseph Priestly, 1770s -- Independently discovered oxygen; Priestly thought air was oxygen plus phlogiston and oxygen absorbed phlogiston during combustion.
- > Antoine Lavoisier, late 1700s -- discovered that the weight of the reactants of combustion equals the weight of products: law of conservation of mass. During combustion, oxygen was removed from the surrounding air. (He got it right! The phlogiston theory died.)

HENRI LOUIS LE CHATELIER

(1850 – 1936)

- Most famous for Chemical Equilibrium Principle
- Unusually good genes for a chemist
 - (His father was an engineer)
- Unusually well educated for a chemist
 - (He had a degree in mining engineering)
- Known for connecting theory and practice
 - * Synthesis of Ammonia * Setting of Cement
 - * Steel and Alloys * Combustion and Explosions
- Technology did not wait for him:
James Watts (1736-1819) ; Nikolaus Otto (1832-91)

How We Made The First Flight



“Wilbur and I were busy in completing the design of the machine itself. The preliminary tests of the motor having convinced us that more than 8 horse power would be secured, we felt free to add enough weight to build a more substantial machine than we had originally contemplated.”

Power and Energy Density

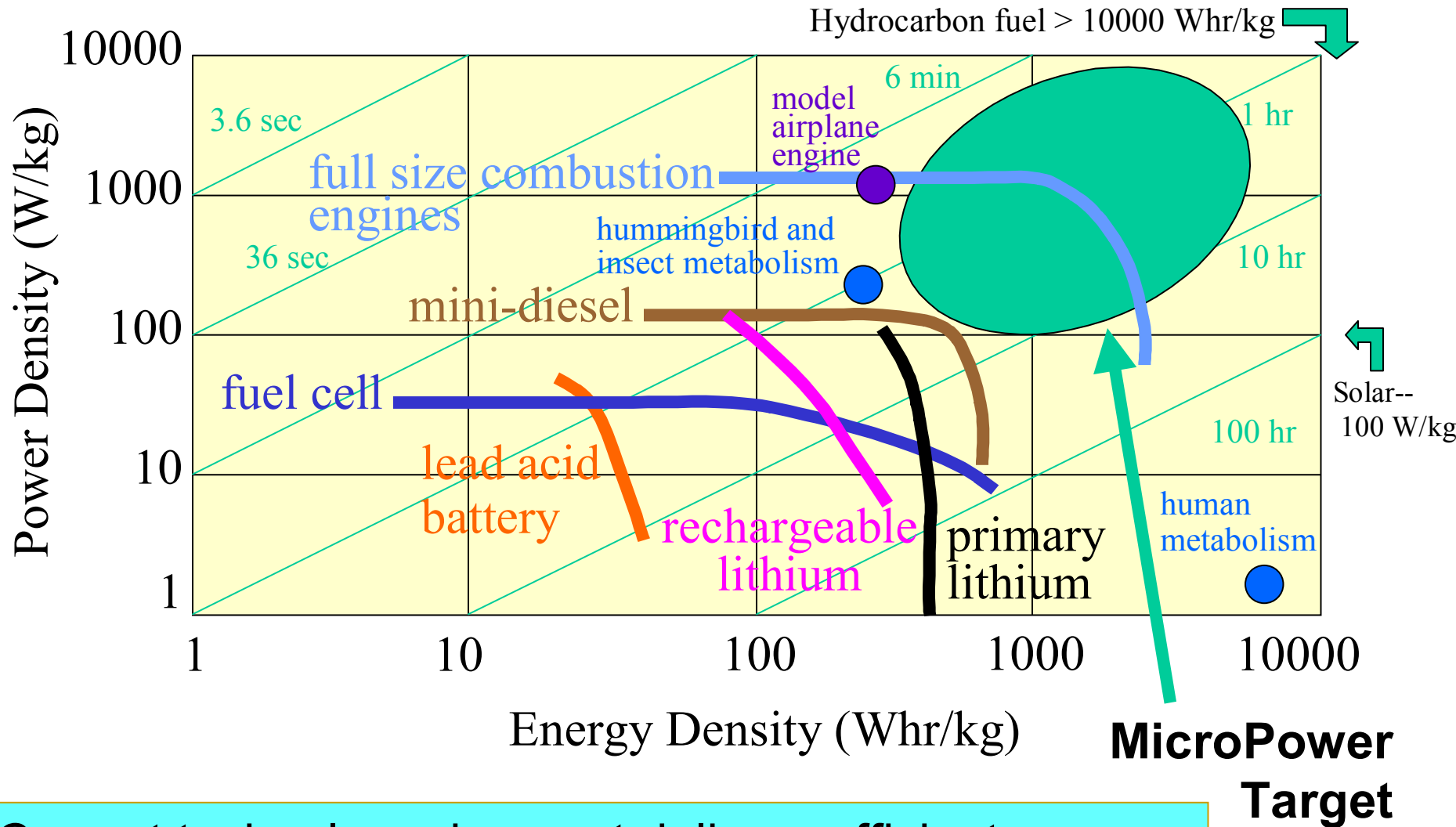

Current technology does not deliver sufficient energy nor power density in the size needed for autonomy

COMBUSTION APPLICATIONS

- ACCIDENTAL FIRE
- SPACE HEATING, COOKING, LIGHTING
- RELIGION
- INCINERATION
- METALLURGY , KILNS
- WEAPONS
- BLASTING
- ENGINES: POWER & PROPULSION

PREMIXED FLAME

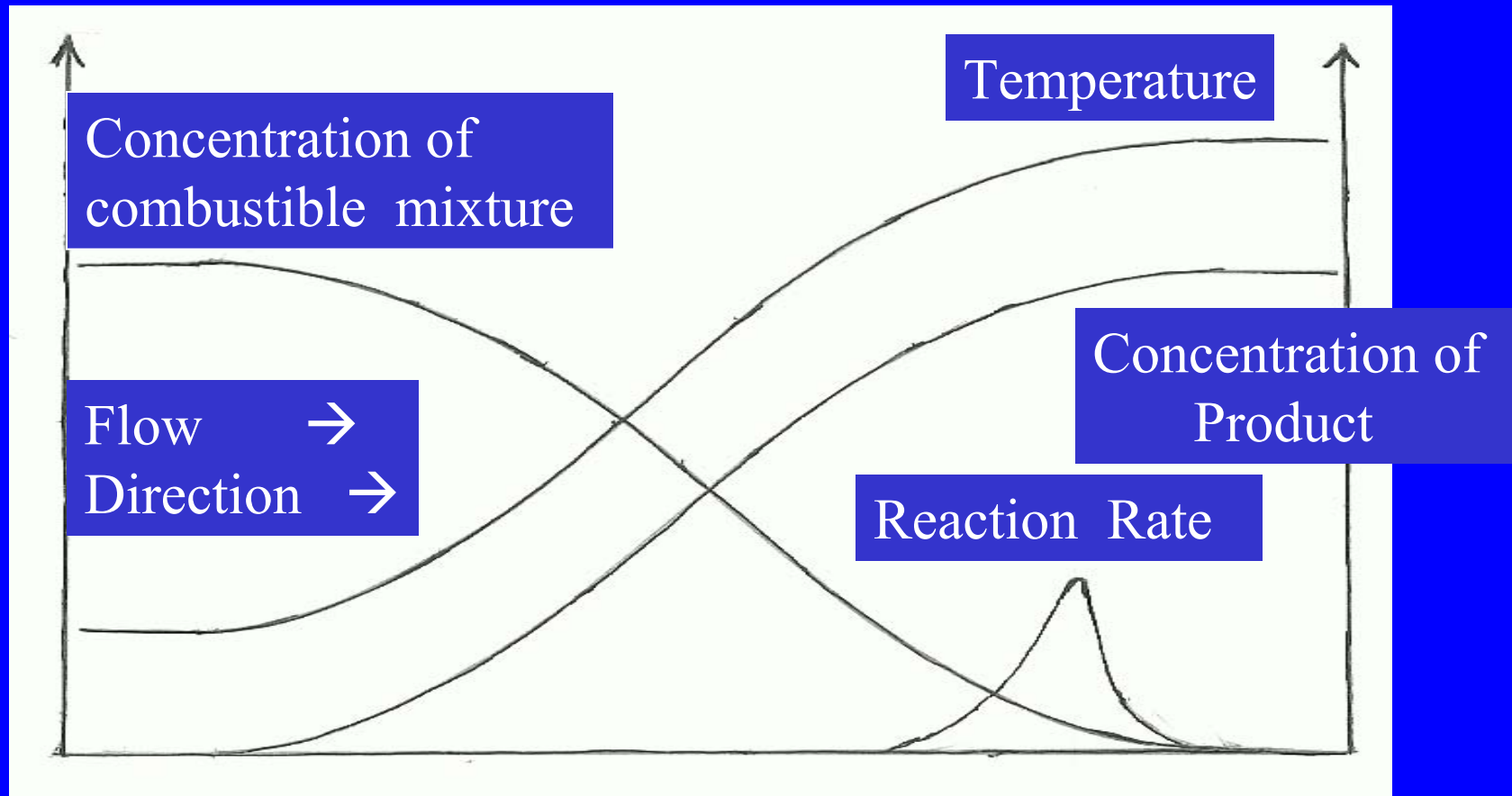

Length coordinate through flame

This type of flame occurs in accidents, Bunsen burners, and spark ignition engines.

DIFFUSION FLAME

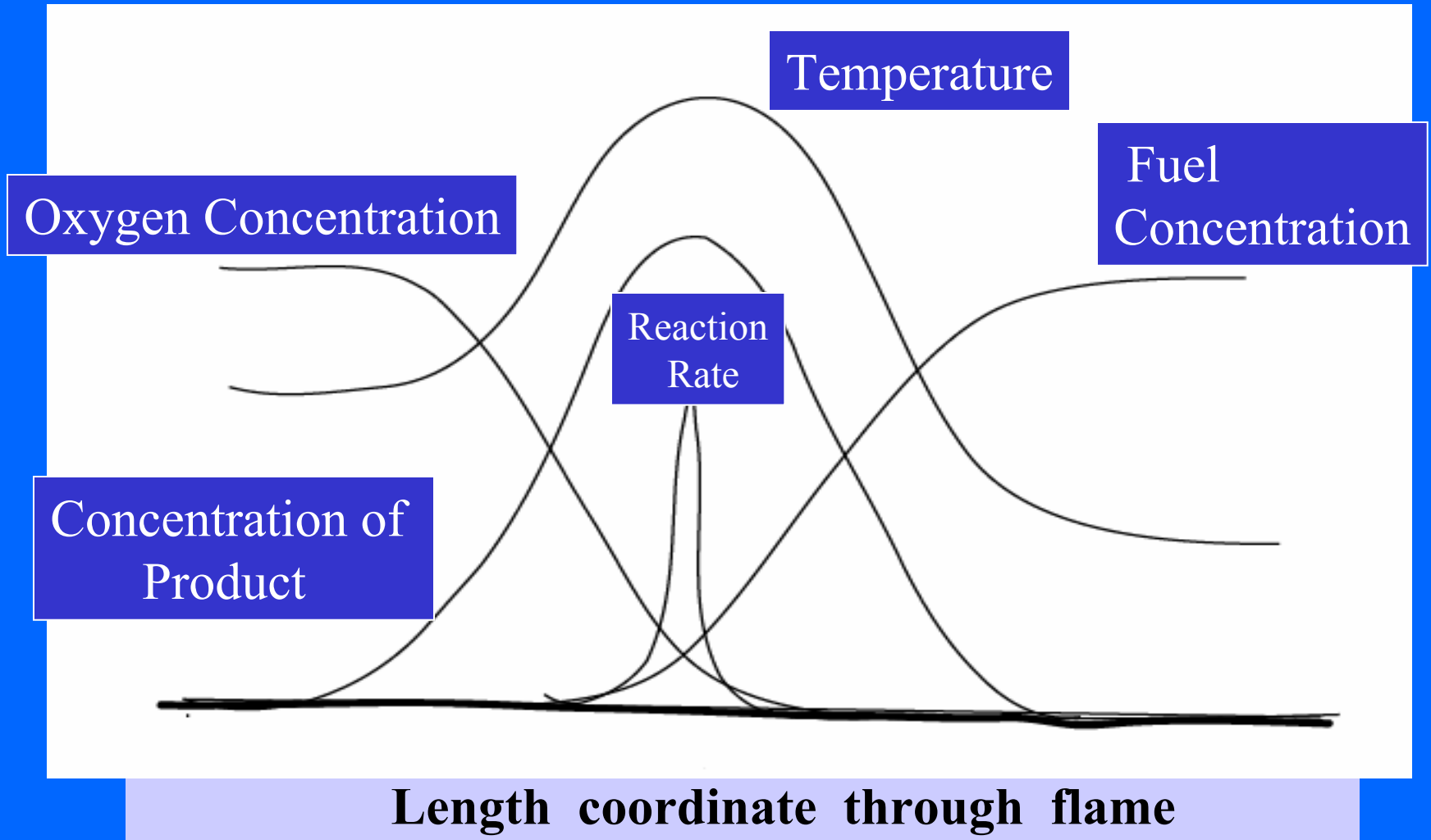

Length coordinate through flame

This type of flame occurs in accidents, oil or coal furnaces, Diesel engines, gas-turbine engines, rocket engines, and incinerators.

SCIENTIFIC FOUNDATIONS

Chemistry –

Thermodynamics –

Heat & Mass Transport –

Fluid Dynamics

Chemists -----

-----*Chemical Engineers* -----

-----*Mechanical & Aerospace Engineers* -----

-----*Physicists* -----

-----*Applied Mathematicians*-----

----- *Computational Scientists*-----

----- *Instrumentation Scientists & Engineers*-----

Combustion Science also attracts material scientists to the challenge of material behavior in very hostile (hot, oxidizing) environments.

THERMODYNAMICS AND EFFICIENCY

- Combustion is a heat addition process; chemical energy is converted to thermal energy (heat) via an exothermic oxidation process; e.g.,



- Sometimes the heat from combustion is needed for the application; more often we want work (power or propulsion). So the heat must be converted to mechanical energy.
- Entropy is a measure of disorder. The greater the disorder, the lower the work that can be obtained from a given amount of heat. So, we try to convert chemical energy to thermal energy (add heat) with a minimal increase in entropy (disorder).

COMBUSTION AT HIGH PRESSURE

- The Second Law of Thermodynamics says that the increase in entropy becomes lower when heat is added at higher temperature:
$$\Delta S = Q / T$$
- At higher pressures, the temperature will be higher and therefore ΔS will be lower. Consequently, more work can be obtained.
- One practical temperature limitation results from a need for materials integrity; confinement must be maintained. No deterioration, softening or melting is allowed.
- Another limitation occurs due to chemical dissociation. Some energy remains in chemical form because bonds break at high temperature:
$$\text{CH}_4 + 2\text{O}_2 + 7.52 \text{N}_2 \rightarrow a \text{CO}_2 + b \text{CO} + c \text{H}_2\text{O} + d \text{H}_2 + e \text{O}_2 + f \text{O} + g \text{H} + h \text{N}_2 + i \text{NO} + j \text{N} + k \text{C} + \text{----}$$

SCALAR EQUATIONS

$$\rho \frac{\partial h}{\partial t} + \rho \mathbf{u} \cdot \nabla h - \nabla \cdot (\lambda / c_p) \nabla h = \rho \dot{w}_F Q + \frac{\partial p}{\partial t}$$

$$h = \sum_i Y_i \int_{T_{ref}}^T c_{pi}(T') dT' = \sum_i Y_i h_i = \int_{T_{ref}}^T c_p(T') dT'$$

$$\rho \frac{\partial Y_i}{\partial t} + \rho \mathbf{u} \cdot \nabla Y_i - \nabla \cdot (\rho D \nabla Y_i) = \rho \dot{w}_i \quad ; \quad i = F, O, P$$

- h is enthalpy, a measure of thermal energy.
- Y_i is the fraction of mass per unit volume (density) associated with species i .

Equations of Fluid Motion

$$\frac{\partial \rho}{\partial t} + \frac{\partial}{\partial x}(\rho u) + \frac{\partial}{\partial y}(\rho v) + \frac{\partial}{\partial z}(\rho w) = 0$$

$$\rho \frac{\partial u}{\partial t} + \rho u \frac{\partial u}{\partial x} + \rho v \frac{\partial u}{\partial y} + \rho w \frac{\partial u}{\partial z} + \frac{\partial p}{\partial x} = \frac{\partial}{\partial x} \left[\frac{2}{3} \mu \left(2 \frac{\partial u}{\partial x} - \frac{\partial v}{\partial y} - \frac{\partial w}{\partial z} \right) \right]$$

$$+ \frac{\partial}{\partial y} \left[\mu \left(\frac{\partial u}{\partial y} + \frac{\partial v}{\partial x} \right) \right] + \frac{\partial}{\partial z} \left[\mu \left(\frac{\partial u}{\partial z} + \frac{\partial w}{\partial x} \right) \right]$$

$$\rho \frac{\partial v}{\partial t} + \rho u \frac{\partial v}{\partial x} + \rho v \frac{\partial v}{\partial y} + \rho w \frac{\partial v}{\partial z} + \frac{\partial p}{\partial y} = \frac{\partial}{\partial x} \left[\mu \left(\frac{\partial u}{\partial y} + \frac{\partial v}{\partial x} \right) \right]$$

$$+ \frac{\partial}{\partial y} \left[\frac{2}{3} \mu \left(2 \frac{\partial v}{\partial y} - \frac{\partial u}{\partial x} - \frac{\partial w}{\partial z} \right) \right] + \frac{\partial}{\partial z} \left[\mu \left(\frac{\partial v}{\partial z} + \frac{\partial w}{\partial y} \right) \right]$$

$$\rho \frac{\partial w}{\partial t} + \rho u \frac{\partial w}{\partial x} + \rho v \frac{\partial w}{\partial y} + \rho w \frac{\partial w}{\partial z} + \frac{\partial p}{\partial z} = \frac{\partial}{\partial x} \left[\mu \left(\frac{\partial w}{\partial x} + \frac{\partial u}{\partial z} \right) \right]$$

$$+ \frac{\partial}{\partial y} \left[\mu \left(\frac{\partial v}{\partial z} + \frac{\partial w}{\partial y} \right) \right] + \frac{\partial}{\partial z} \left[\frac{2}{3} \mu \left(2 \frac{\partial w}{\partial z} - \frac{\partial u}{\partial x} - \frac{\partial v}{\partial y} \right) \right]$$

FLUID DYNAMIC PHENOMENA

- Shock waves -- increase pressure temperature and reaction rates, important in detonations.
- Turbulent fluctuations -- enhance mixing rates and thereby accelerate combustion rates, also enhance heat losses.
- Flow separation – allows jet formation with associated penetration, wake or cavity recirculating flow formation which protects flame in its ignition region.

SHOCKWAVE WITH TURBULENT WAKE

NASA Ames
Shadowgraph
of
supersonic air
flow over
blunt body

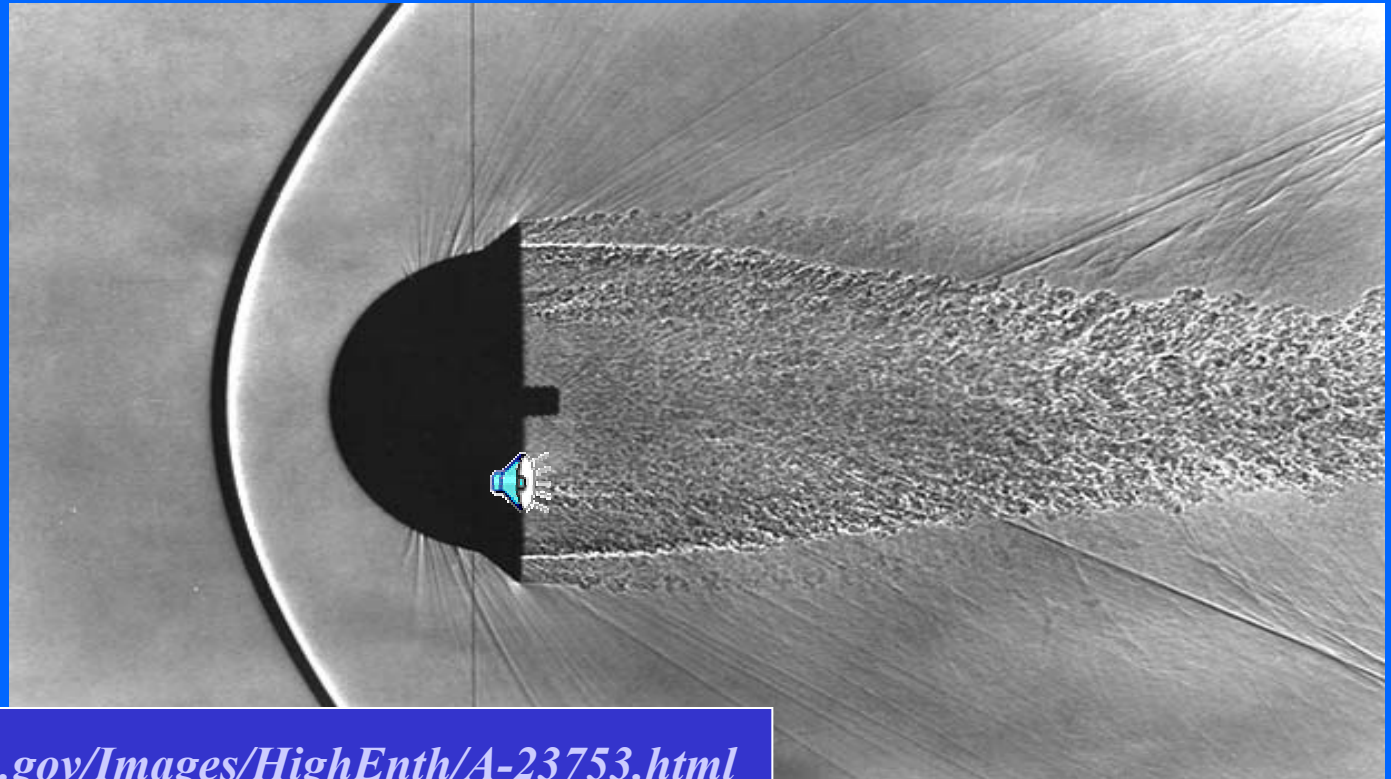

<http://ails.arc.nasa.gov/Images/HighEnth/A-23753.html>

- Shockwave forms in high speed (supersonic) flow.
- Blunt object creates aft recirculation zone in the near wake.
- Recirculation zones provide protected low speed regions for ignition and flameholding.
- Wake can become turbulent at high speeds, enhancing mixing.

SEPARATED FLOW (JET) WITH TURBULENT TRANSITION

Helium jet flowing
into air; $U = 70 \text{ m/s}$,
 $Re = 10,000$

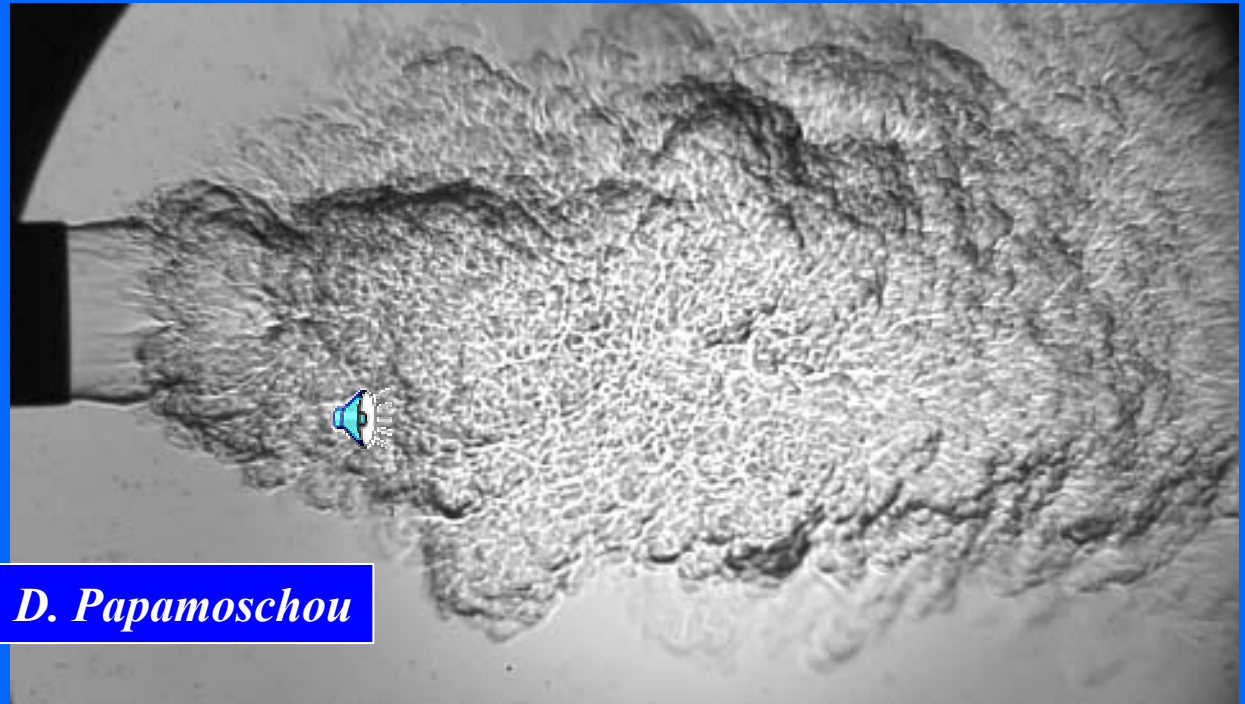

Courtesy of Prof. D. Papamoschou

- The fluid leaves (separates from) the wall of the tube to form a jet.
- Then, the laminar (smooth) flow transitions to turbulent (rough) flow.
- Jets allow penetration of one fluid into another.
- Turbulence enhances mixing rates.

MULTIPLE & DISPARATE LENGTH AND TIME SCALES

- Chemical times, usually fast, different scales for different reactions. Reaction zone size.
- Mass diffusion, heat diffusion times. Diffusion lengths.
- Flow or residence times. Chamber size.
- Turbulent eddy length and time scales.
- Multiple and disparate lengths and times present challenges to measurement science.
- Multiple and disparate lengths and times present challenges to computational science.

NON-INTRUSIVE MEASUREMENTS IN HOSTILE ENVIRONMENTS

Coherent Anti-Stokes
Raman
Spectroscopy (CARS)

*Courtesy
of
Prof. D. Dunn-Rankin*

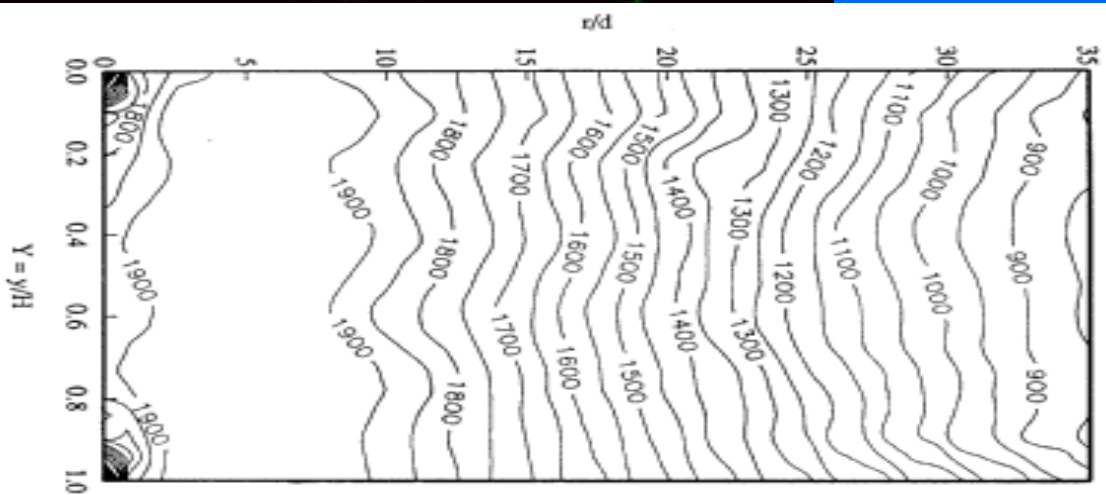
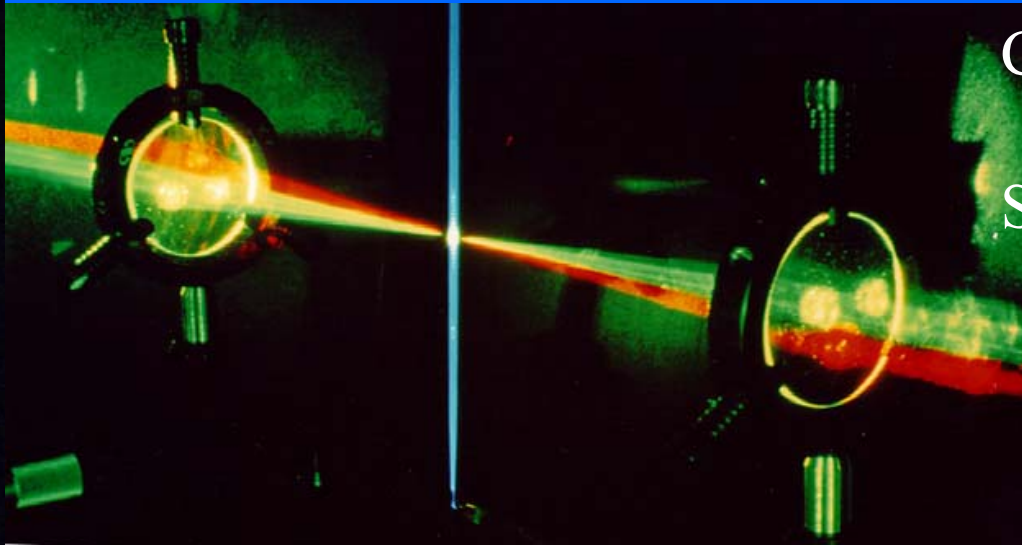

EXAMPLES OF SCIENTIFIC AND TECHNOLOGICAL CHALLENGES

- > **Fuel Droplets and Sprays - *diffusion flames***
 - individual droplet behavior at subcritical thermodynamic conditions
 - individual droplet behavior at supercritical thermodynamic conditions
 - spray behavior in a combustor
 - formation of a spray, atomization



- > **More Efficient Engines -- Turbine Burner**
- > **More Compact Engines -- Liquid-Film Combustors**
- > **Fire Safety -- Flame Spread Above Liquid Fuels**
 - at earth gravity conditions
 - in spacecraft conditions

CONVECTIVE DROPLET VAPORIZATION

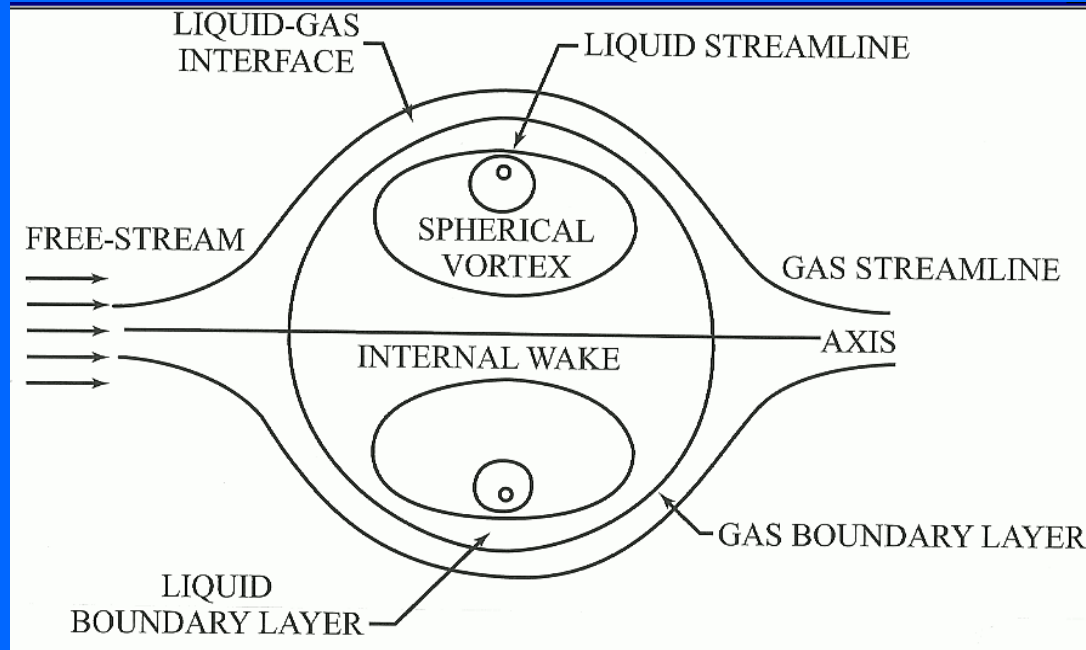

Internal circulation enhances heating and vaporization.

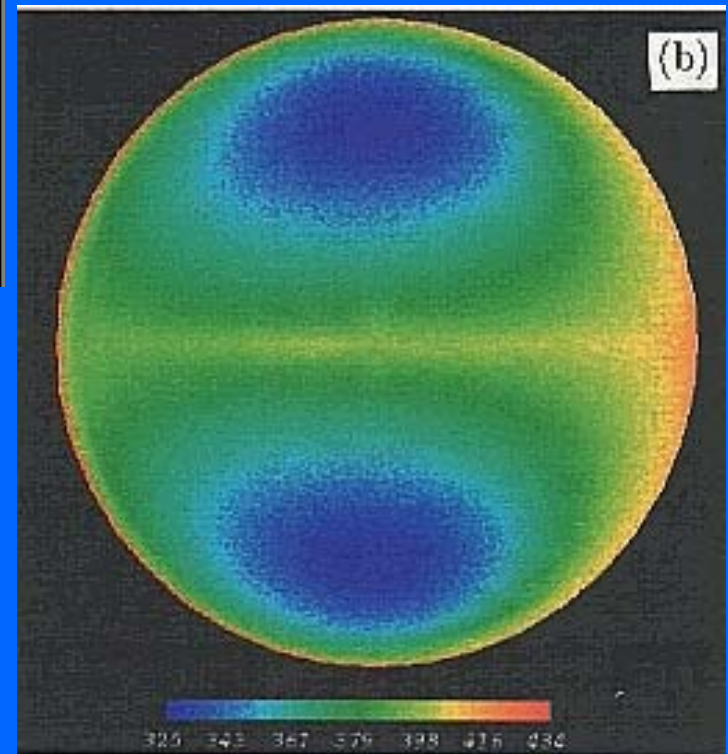
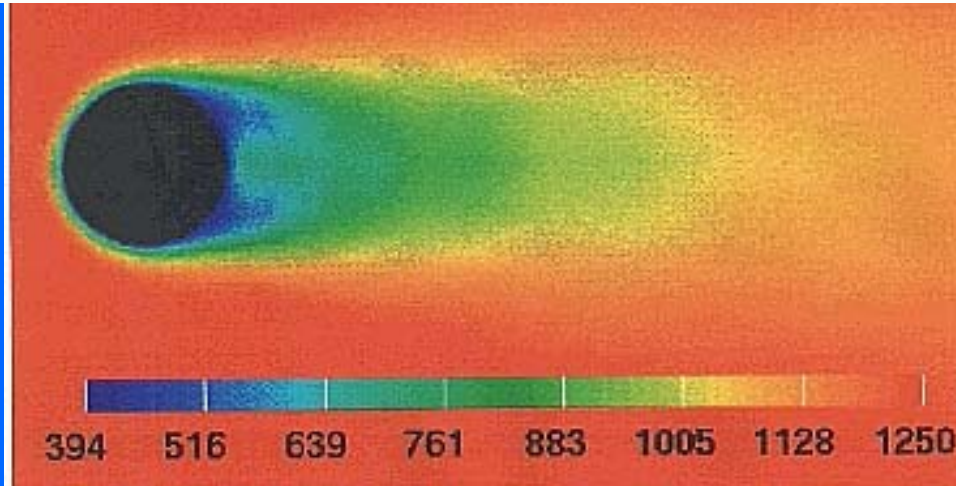

CENTER-BODY FUEL INJECTION

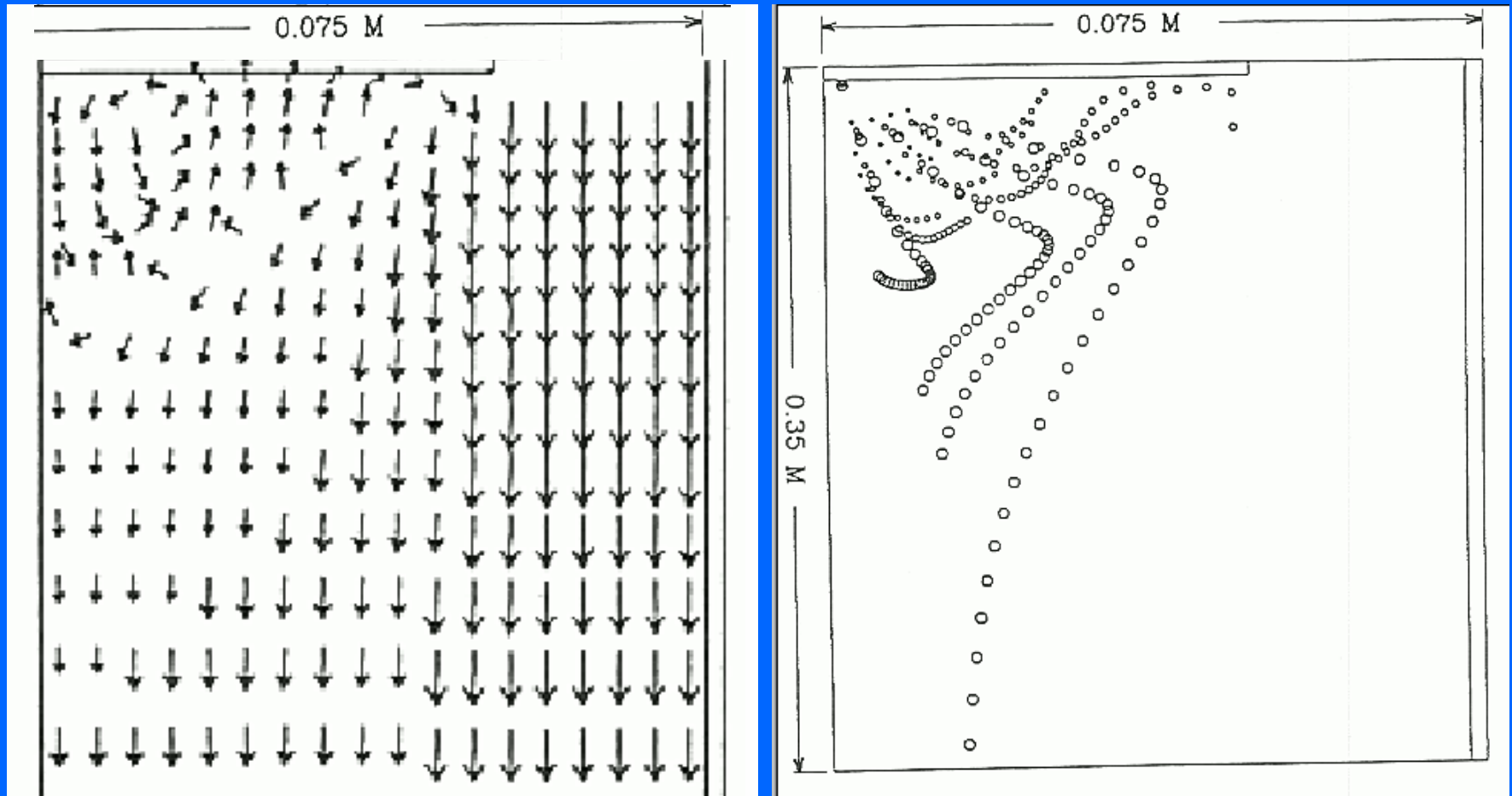

Polydisperse spray injected into recirculating, turbulent reacting gas.

CRITICAL THERMODYNAMIC CONDITIONS

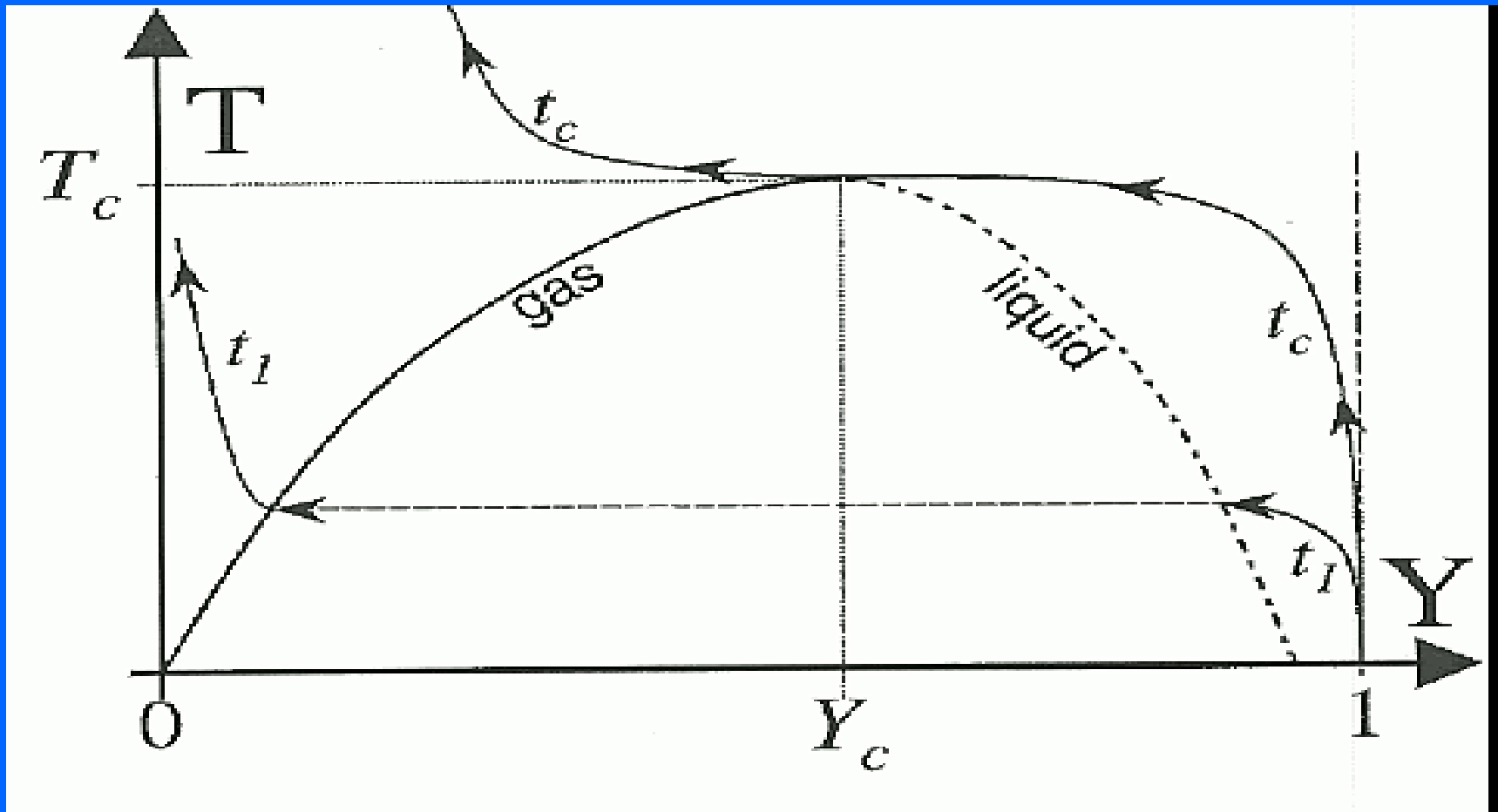

At high pressures and temperatures,
there is no distinction between phases.

DROPLET VAPORIZATION IN SUPERCRITICAL GAS

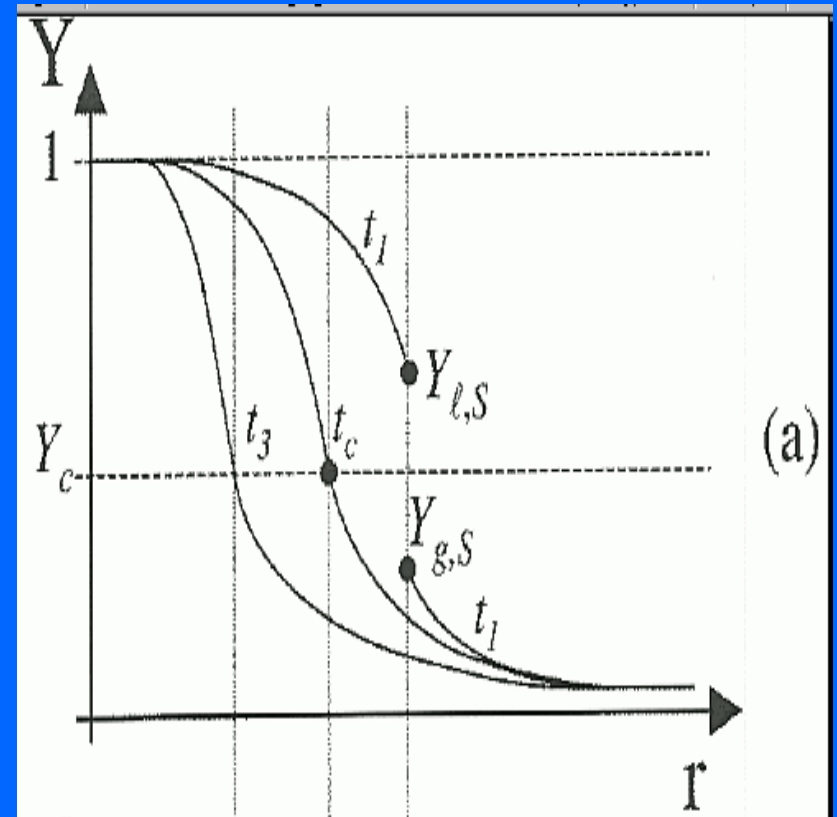
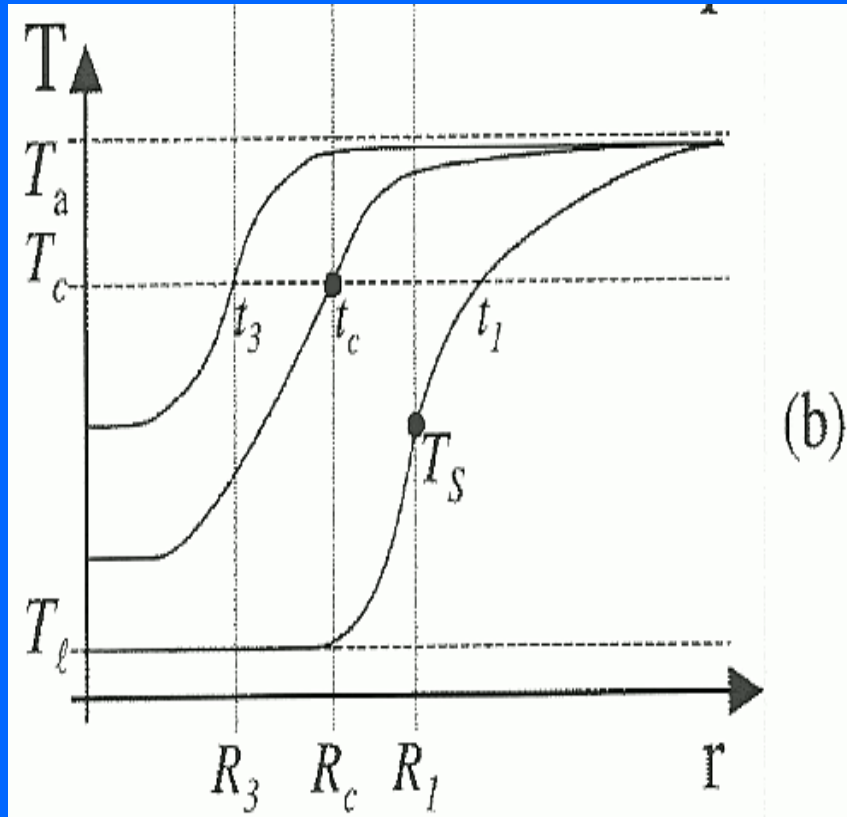

Ambient gas begins at supercritical state but cold droplet is subcritical. As the droplet is heated, the critical surface moves towards the droplet surface. When the surface is reached, distinction between the phases disappears.

OXYGEN DROPLET VAPORIZING IN HYDROGEN GAS

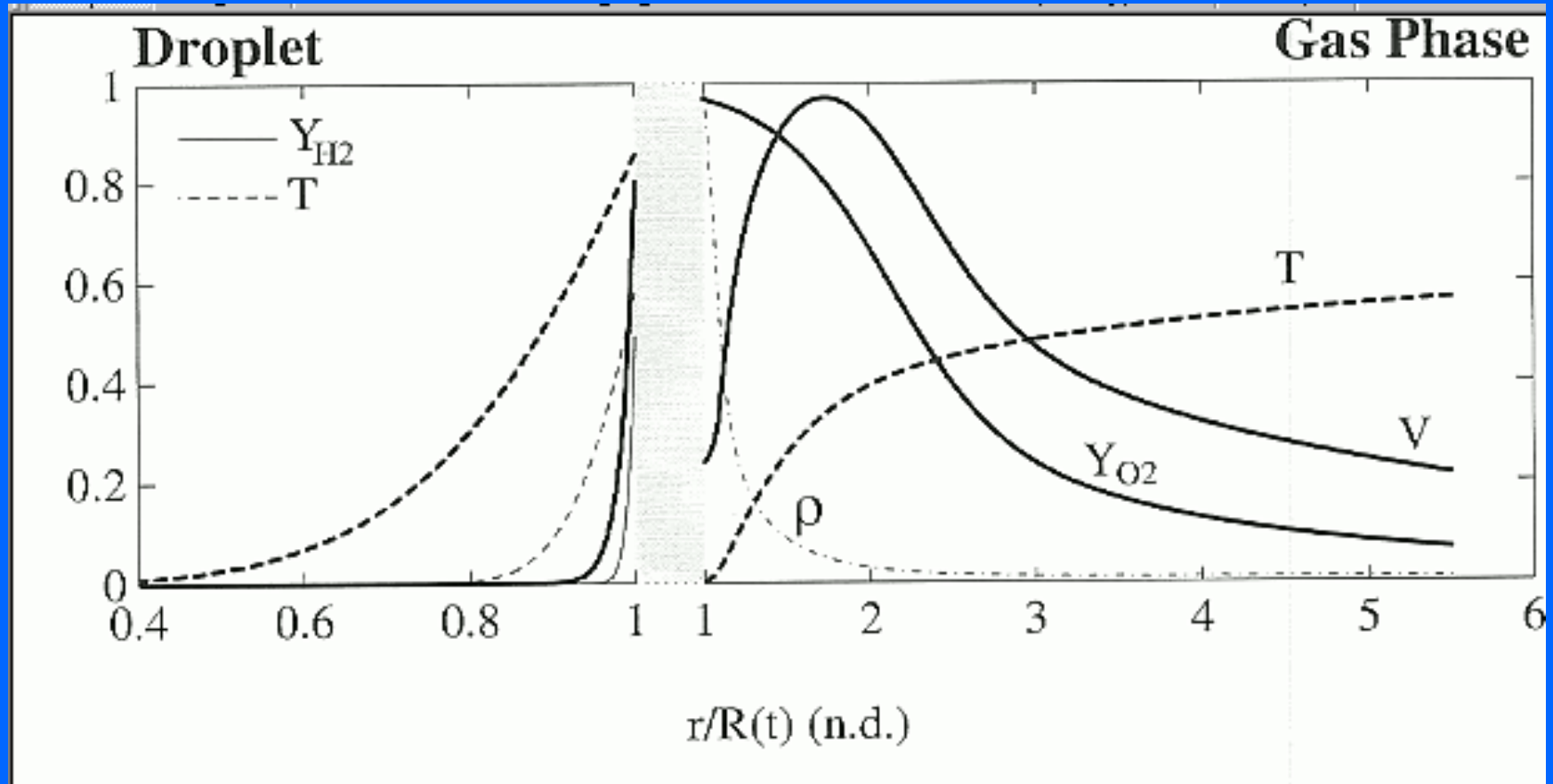

Existing Experimental Investigations of Liquid-Phase-Modulated Sprays

Fan Sheet

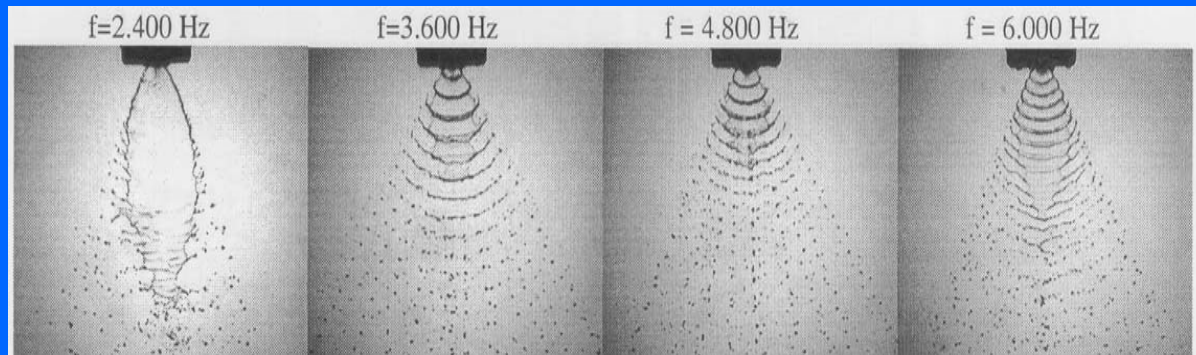

Conical Sheet

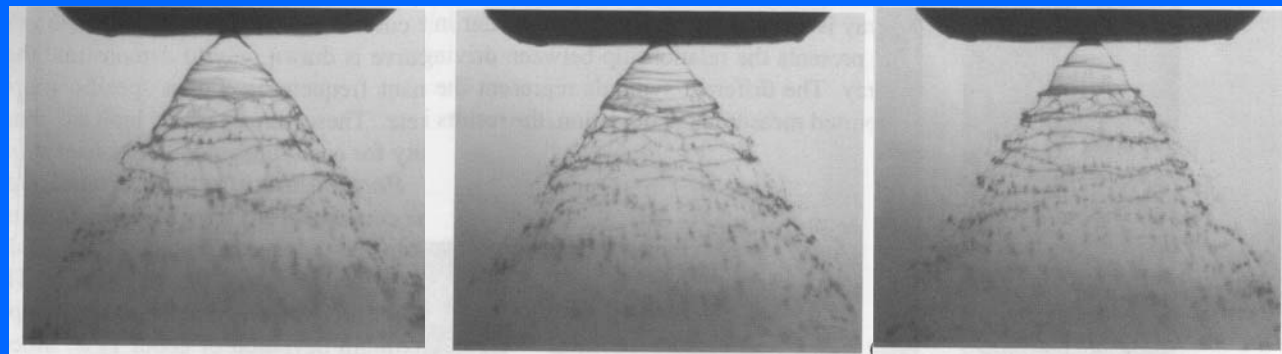

Sources: I.-P. Chung et al. 1998 (Conical Sheet);

Brenn, Rensink & Durst 2000 (Fan Sheet)

SPRAY ATOMIZATION

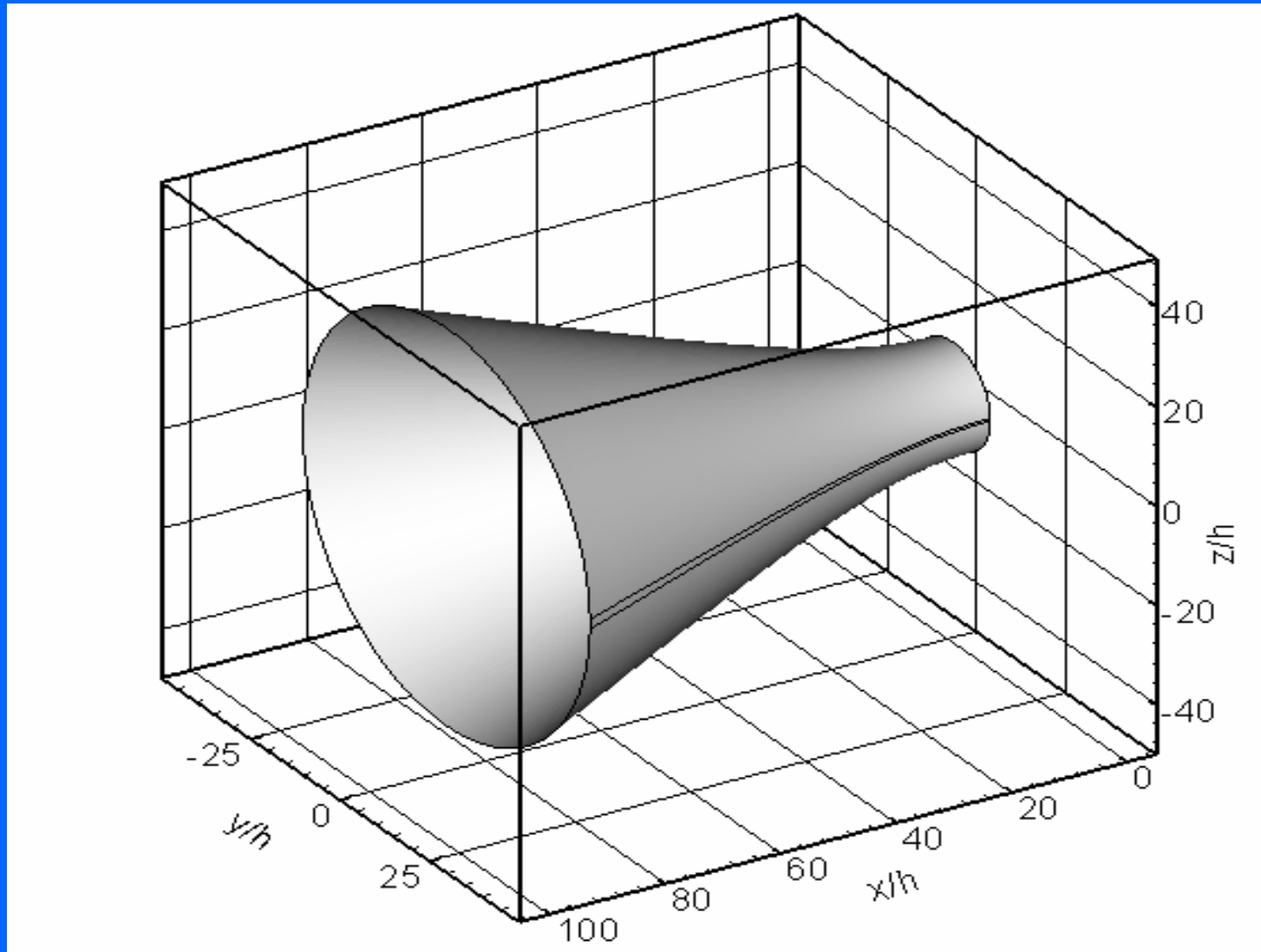

Liquid sheet is injected in a hollow “conical” form to maximize surface area and rate of droplet formation.

*Courtesy of
Dr. C. Mehring*

TURBOFAN CYCLE

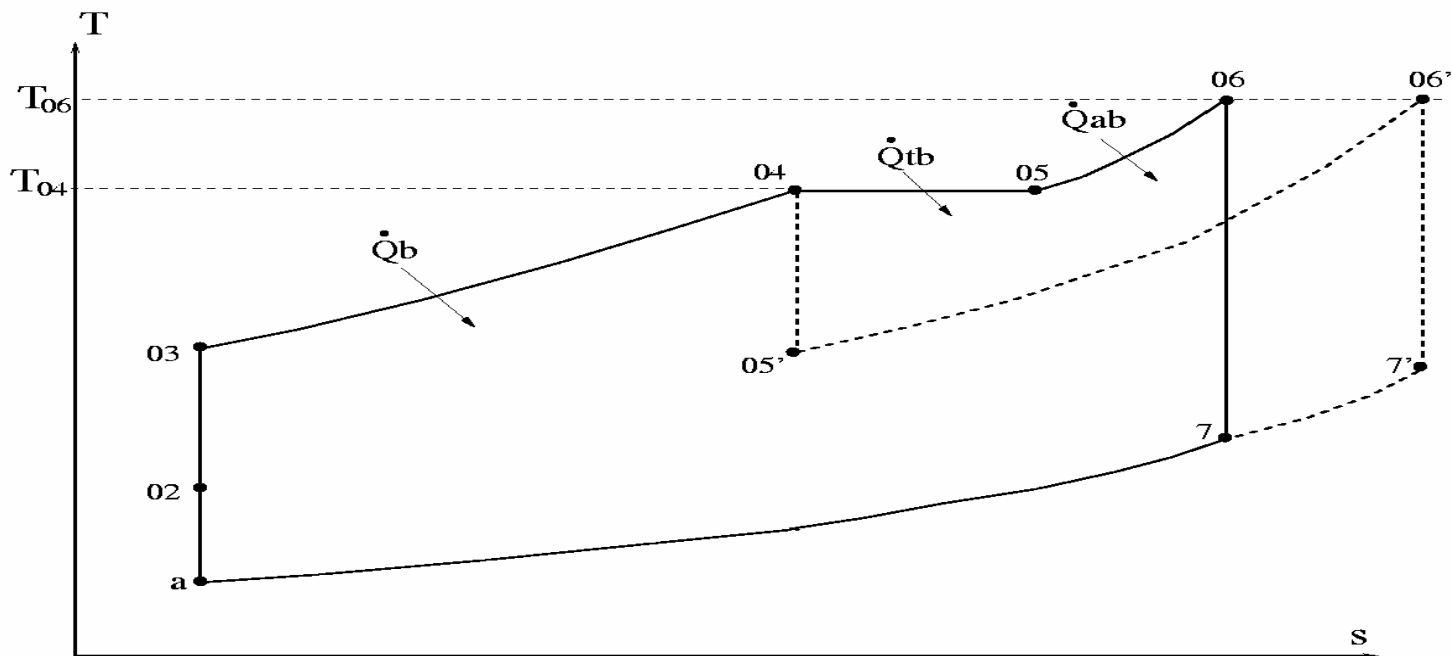
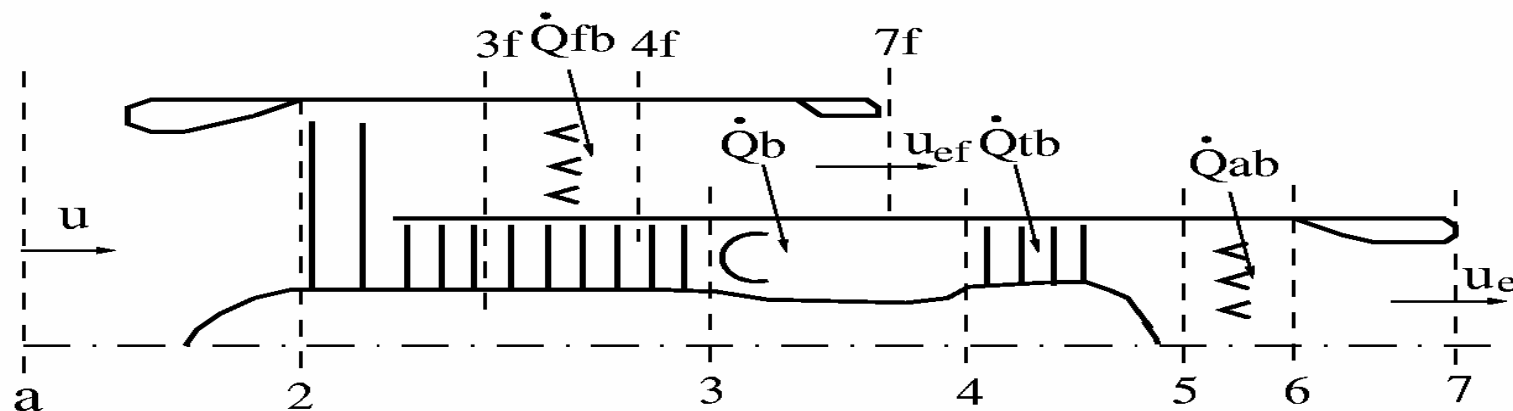

TURBINE PASSAGE FLOW

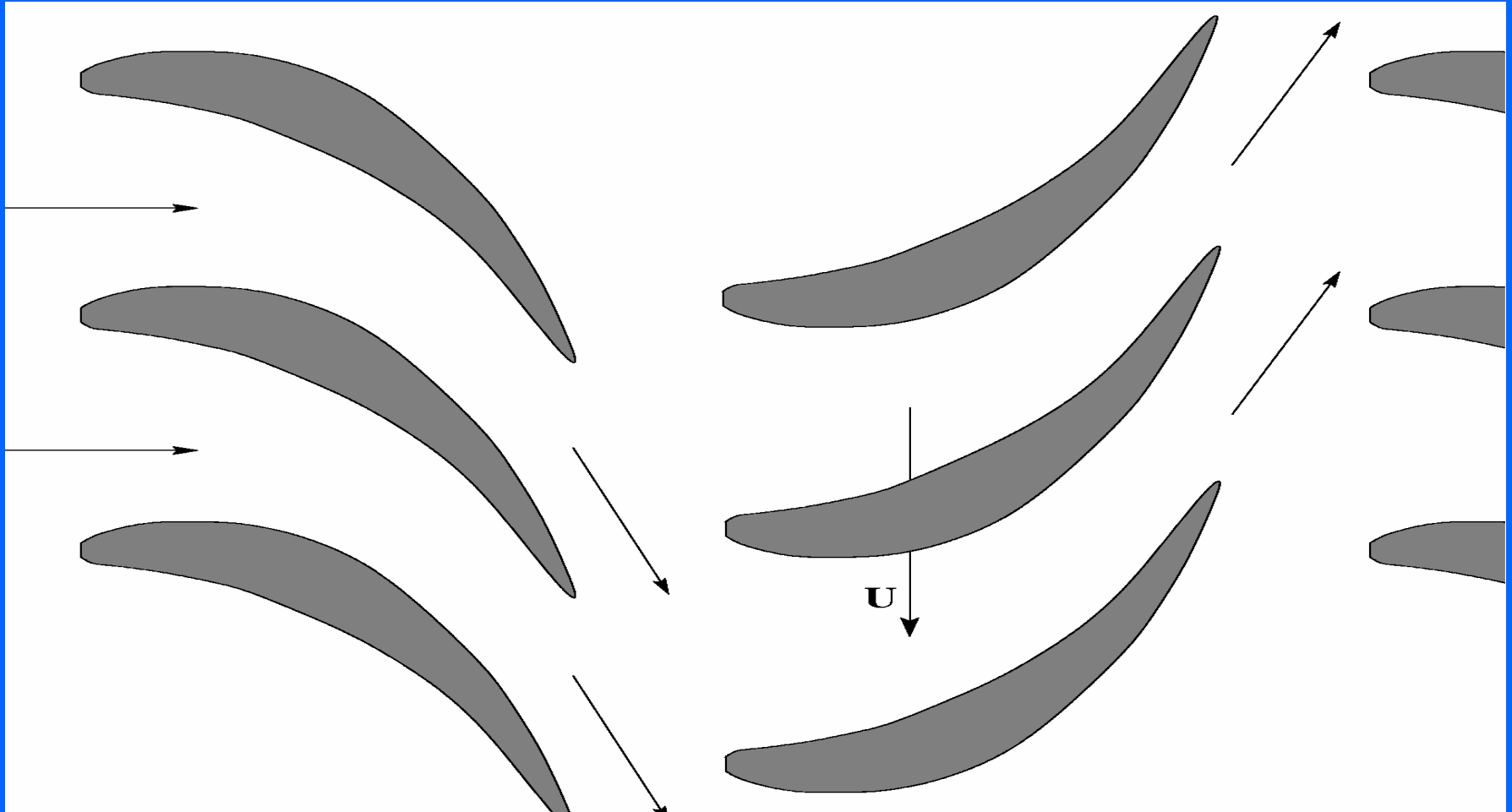

Flow accelerates through transonic range and turns ;
streamwise and transverse accelerations can be $O(10^5 g)$

TURBINE BURNER CONCEPT

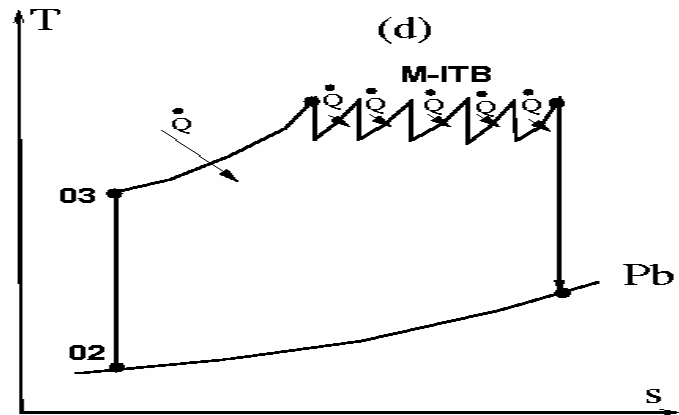
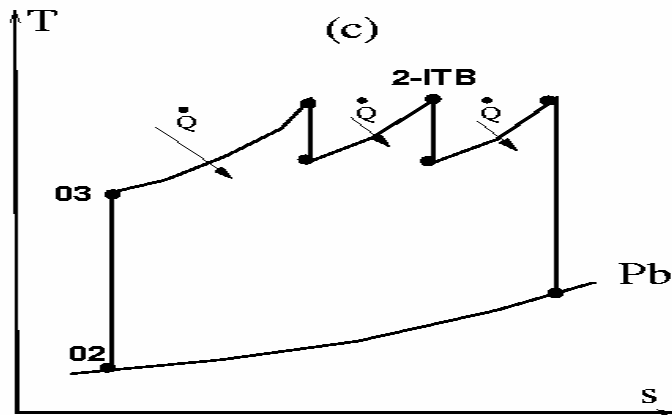
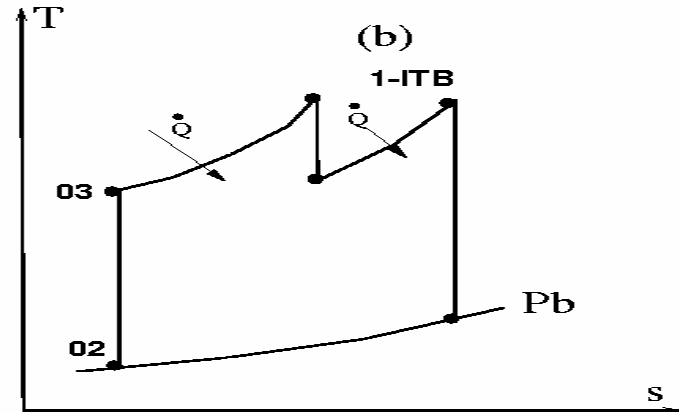
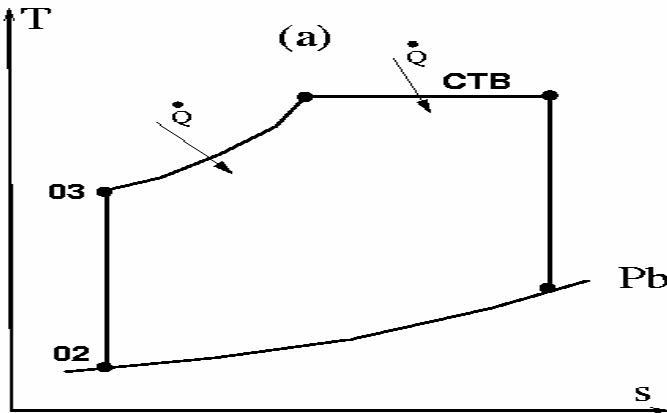

Burning in the turbine has advantage in a temperature - limited system; many stator burners approach continuous burner.

TURBOJET PERFORMANCE VS. COMPRESSION RATIO

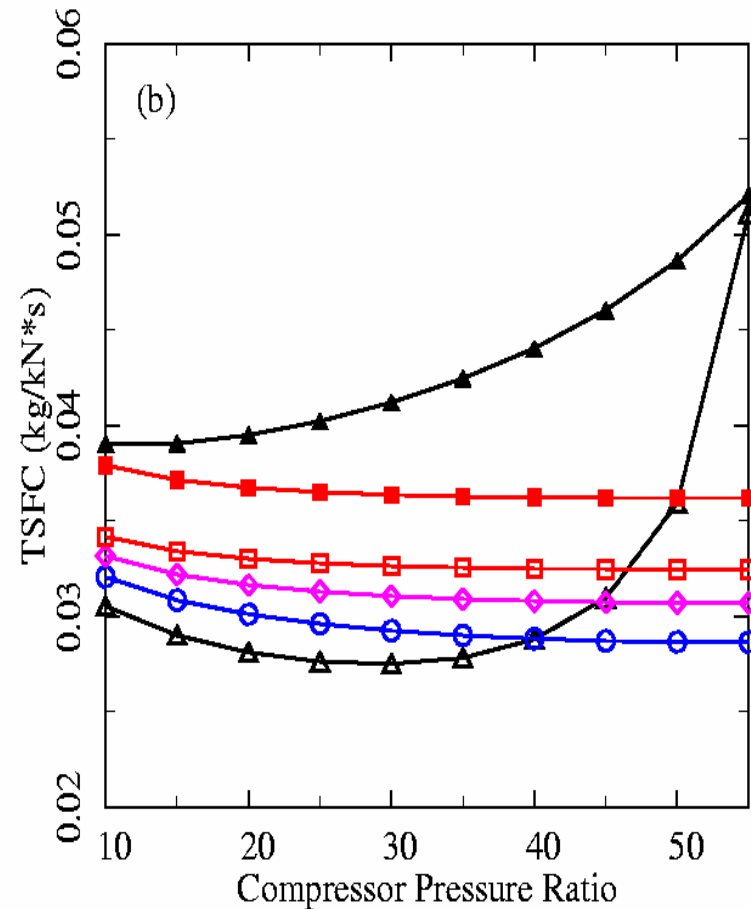
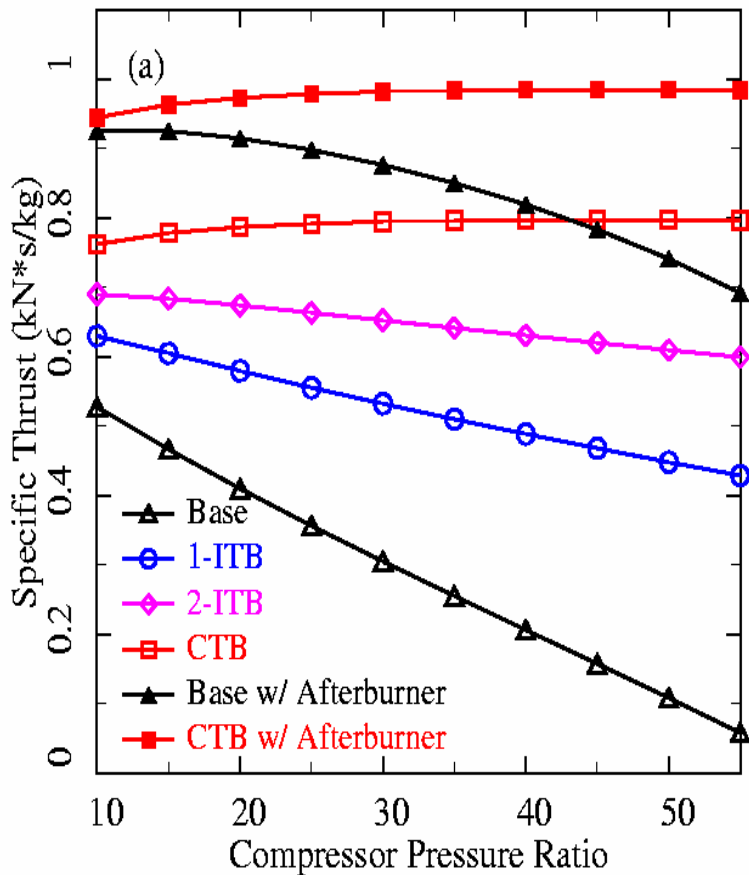

$$M = 2, \quad T_4 = 1500 \text{ K}, \quad T_6 = 1900 \text{ K}$$

TEMPERATURE AND MACH NUMBER

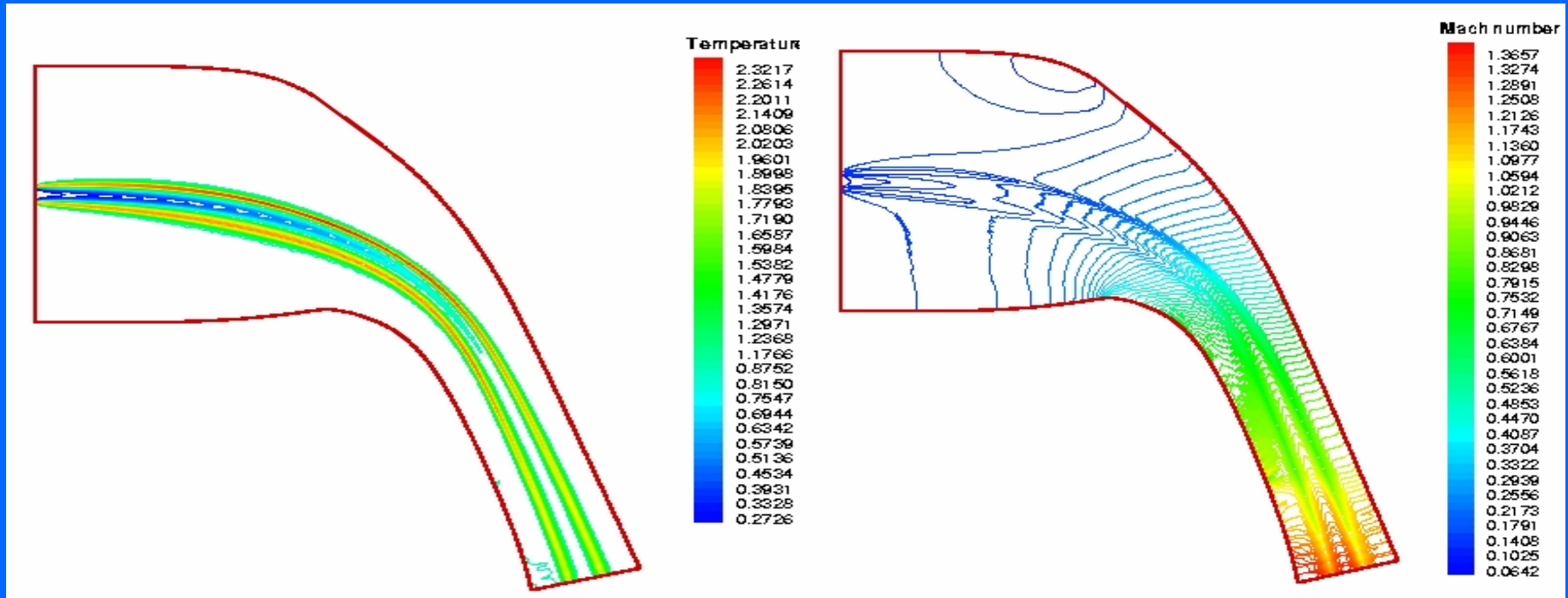

Fuel injection into curved, convergent-divergent channel
Typical of turbine blade passage. Mixing and reaction occur
in a diffusion flame while flow turns and accelerates
at about 10^5 g.

LIQUID-FILM COMBUSTOR: Conceptual Design

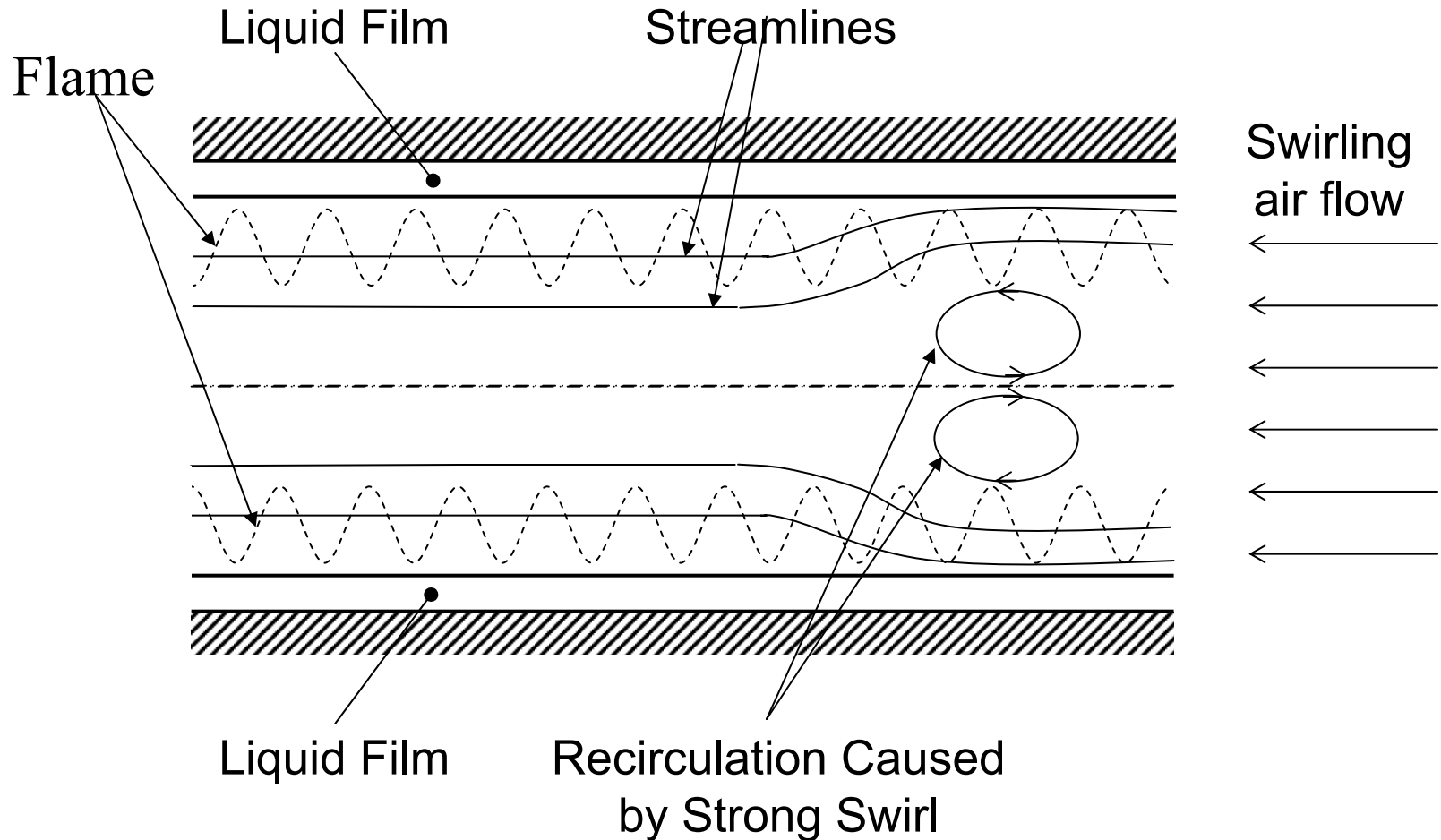

LIQUID-FILM COMBUSTOR

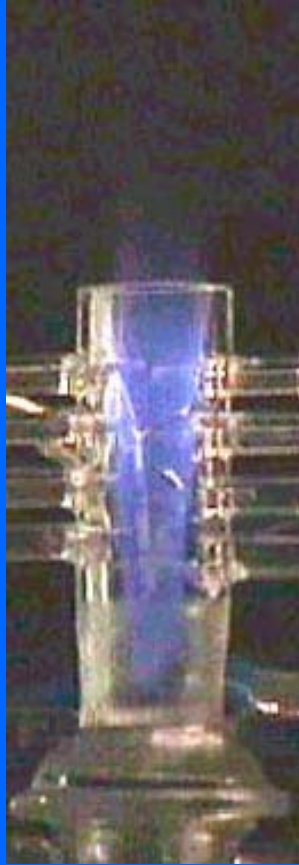

- Methanol/methane /air and heptane/air burns internally
- Pure gas flame not internal
- Swirl control

Pyrex combustor



NASA MICROGRAVITY FACILITIES

- > Space Shuttle
- > Sounding Rockets
- > KC-135
- > Drop Towers

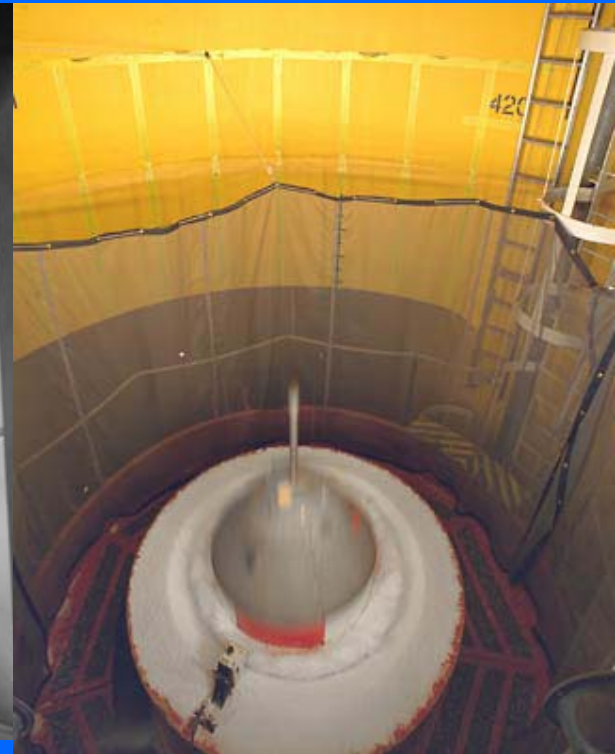

NASA Microgravity Program

FLAMES ABOVE LIQUID FUELS

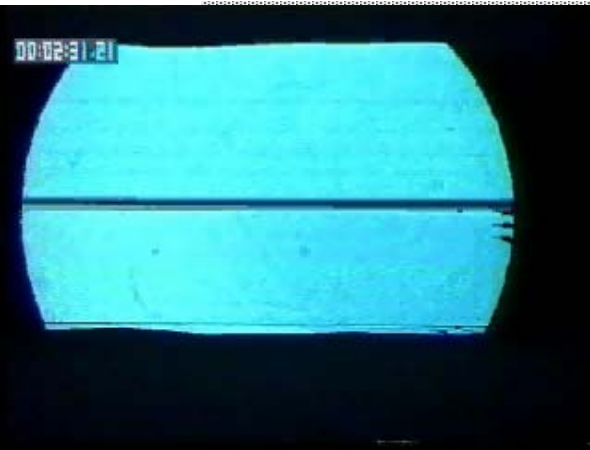
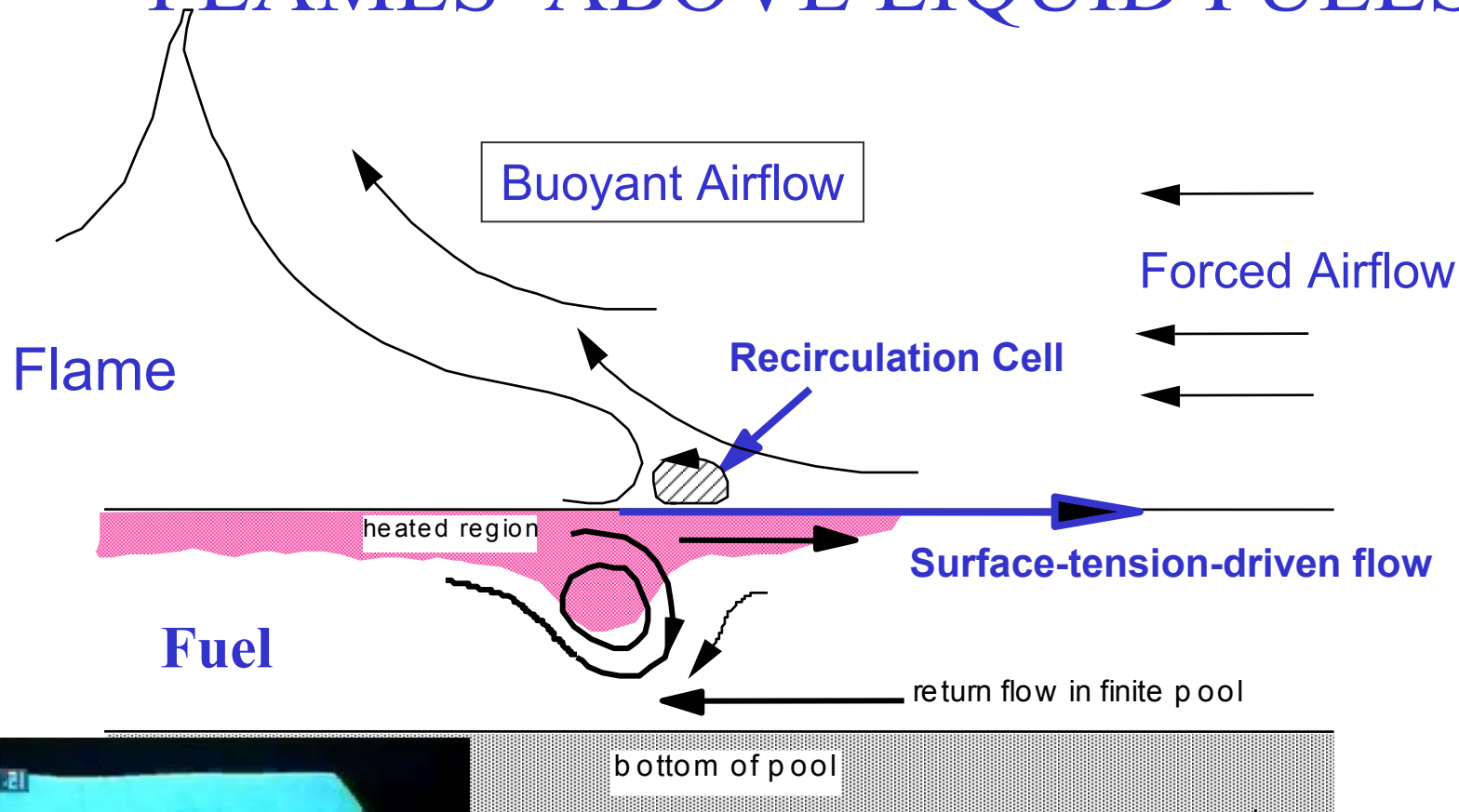

Courtesy of Dr. H.D. Ross, NASA Glenn

FLAME SPREAD COMPUTATION

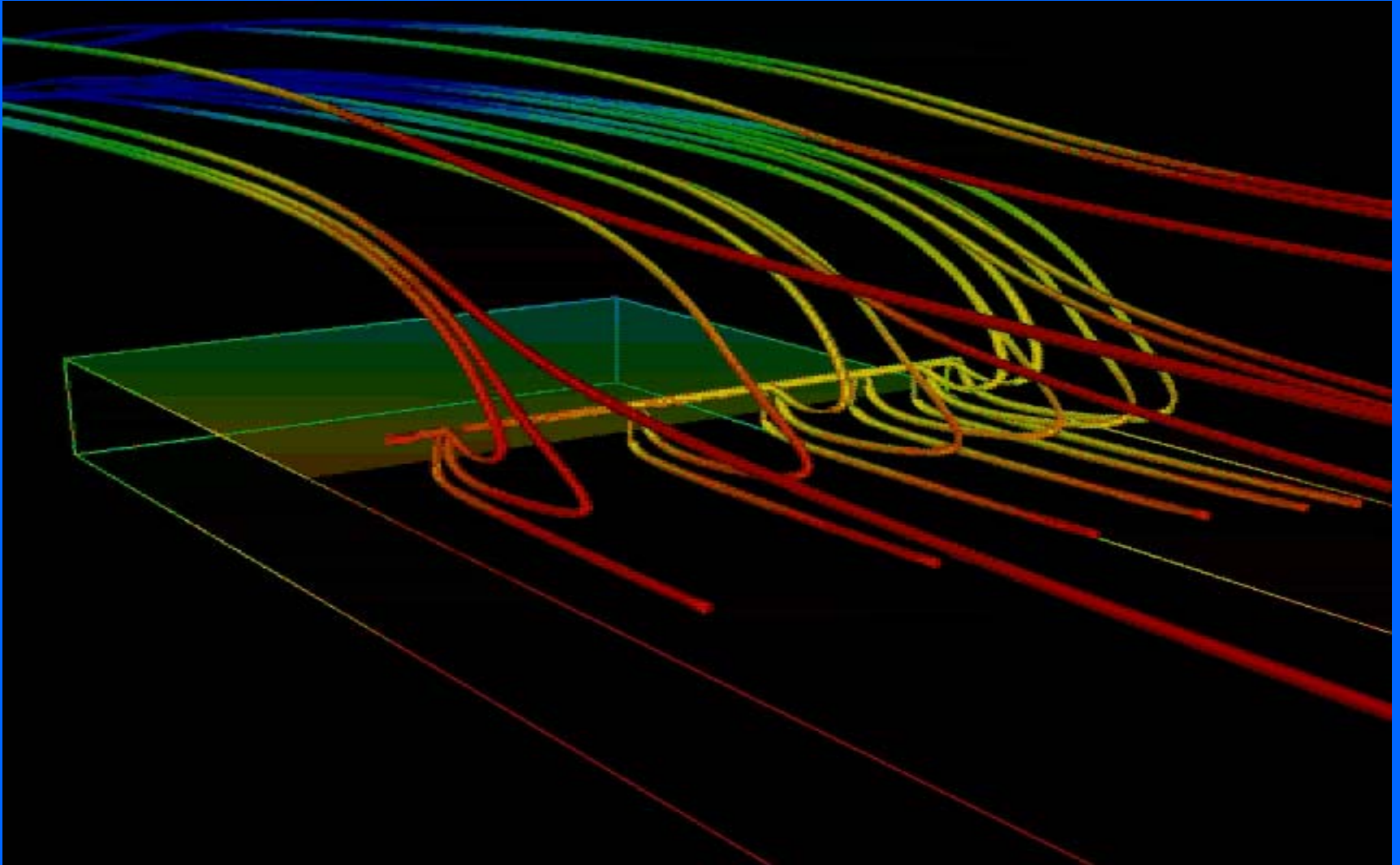

FLAME SPREAD COMPUTATION

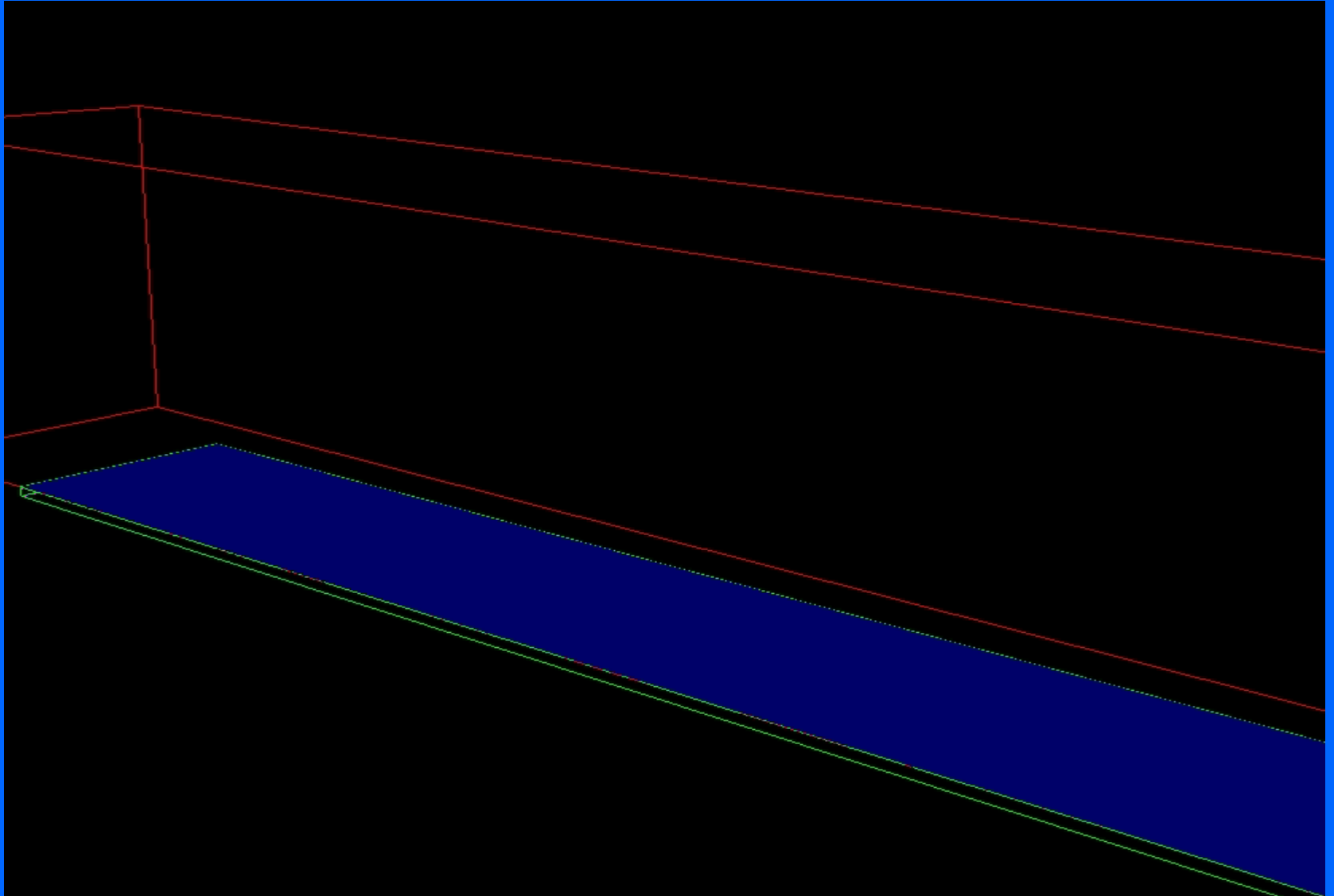

Thank you for your attention.

Power and Energy Density

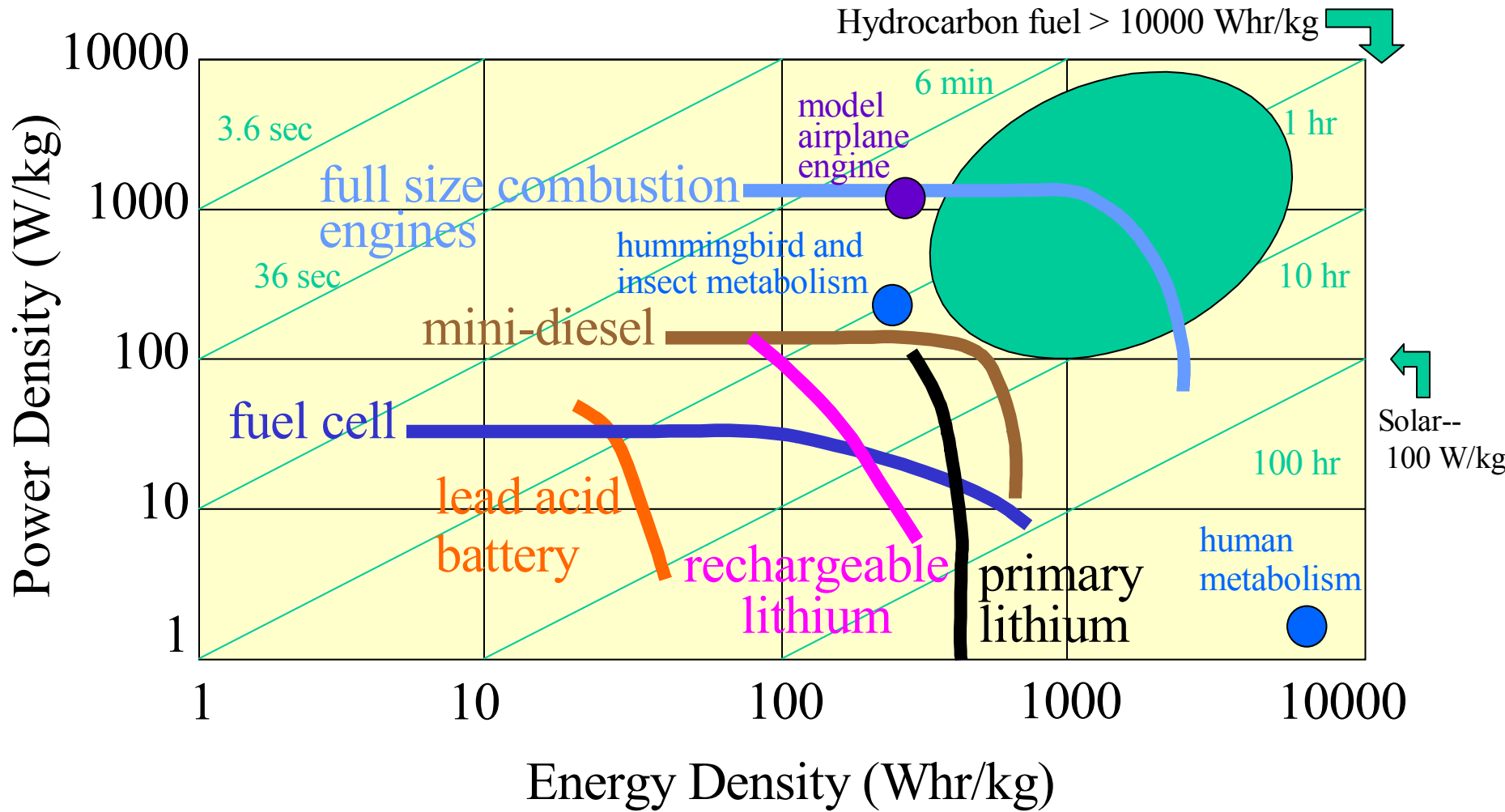

Courtesy of Prof. D. Dunn-Rankin

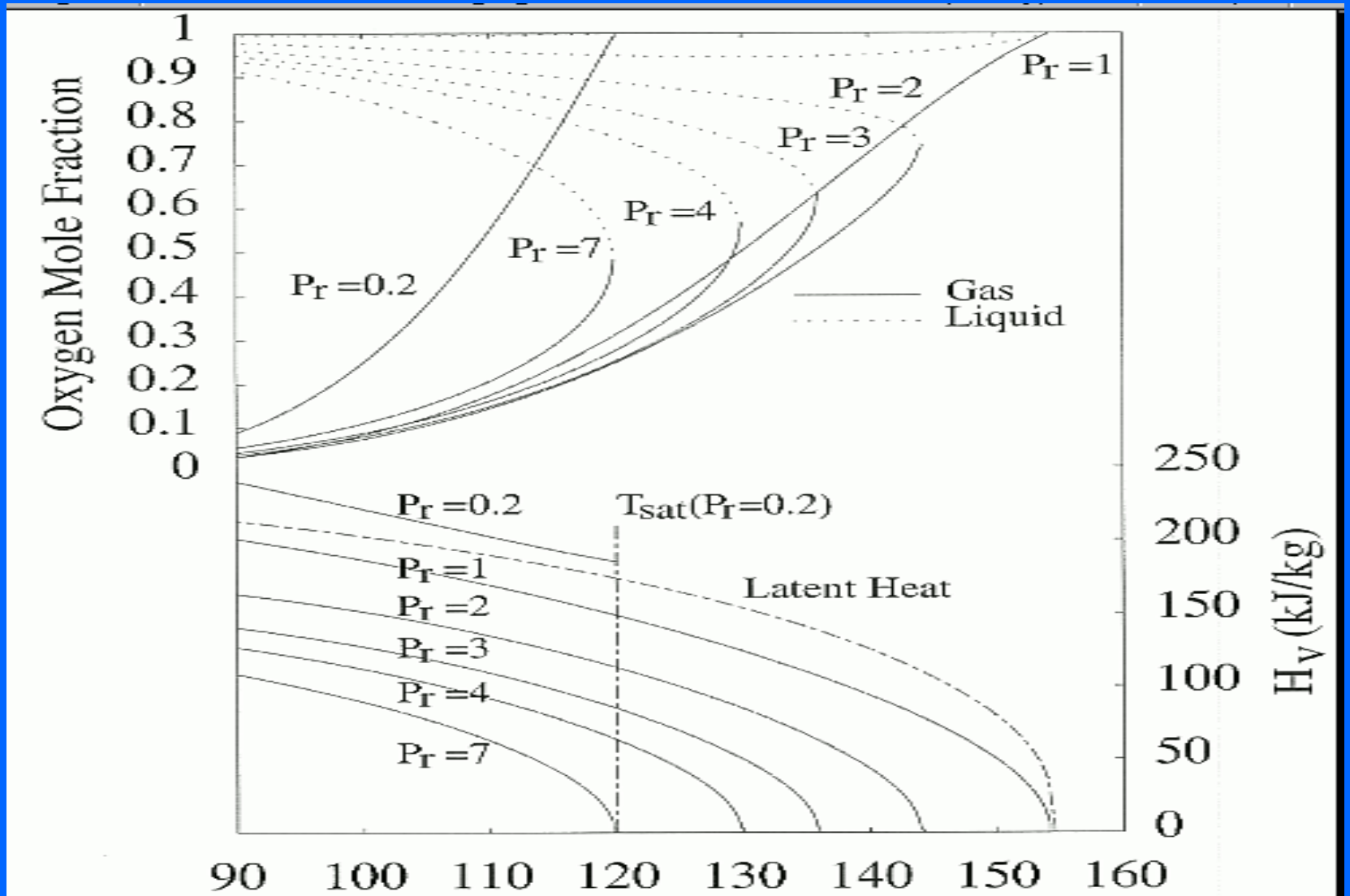

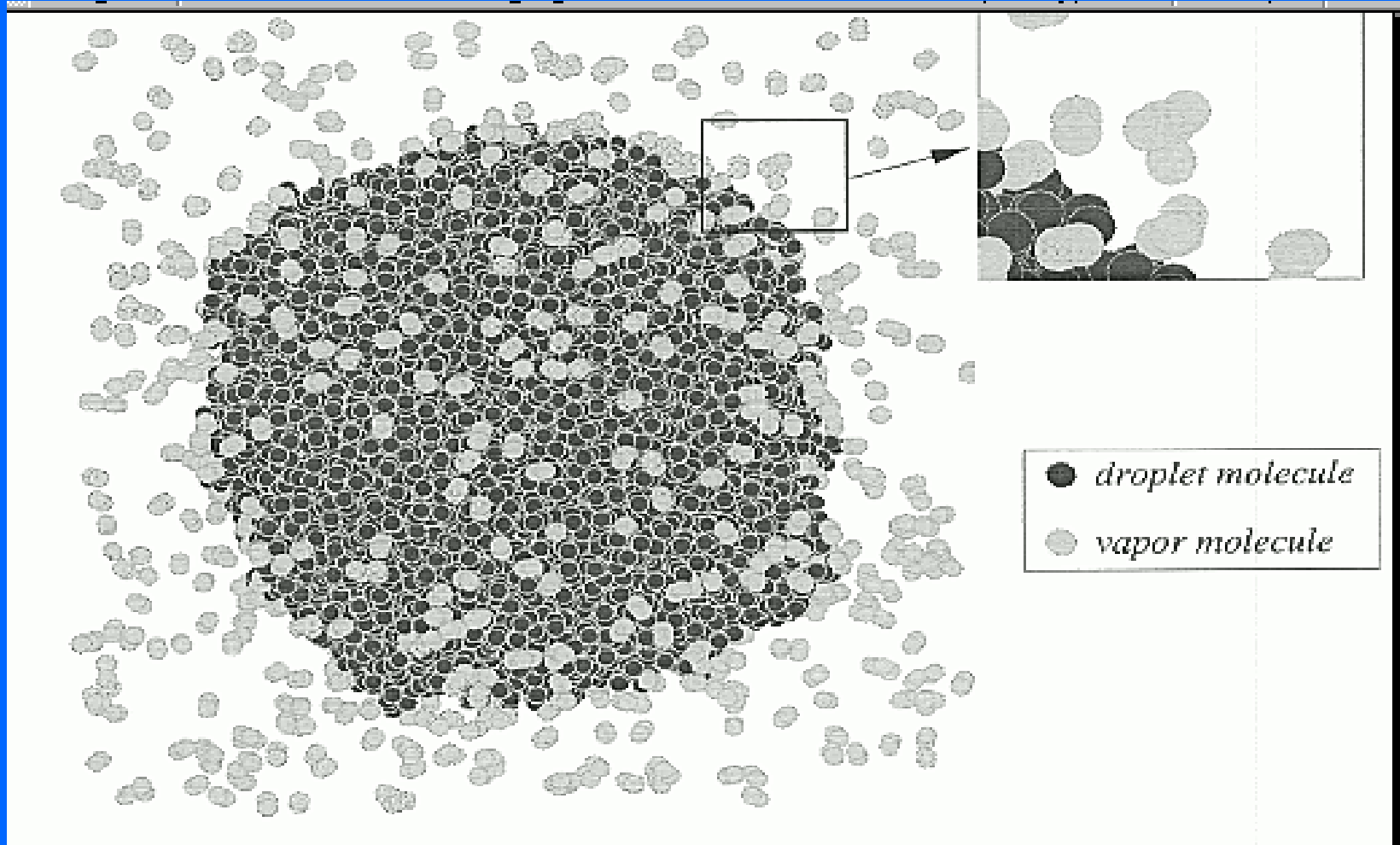

ACKNOWLEDGEMENTS

**Collaborating Faculty --D. Dunn-Rankin, D.K. Edwards,
S.E. Elghobashi, F. Liu, D. Papamoschou, R.H. Rangel**

**Collaborators from other Organizations -- F.J. Miller, H.D. Ross, NASA;
G. Fix, S.C. Yao, CMU; H.D. Dwyer, UCSD; B. Sanders, Sandia Labs**

**Postdoctoral Researchers -- B. Abramzon, S.K. Aggarwal, J. Cai,
B. M. Cetegen, G. Continillo, E. Gutheil, I. Kim, C.M. Megaridis,
C. Mehring, M.S. Raju, I. Silverman, F.H. Tsau**

**Graduate Student Researchers-- R. Bhatia, F. Cheng, C.H.Chiang,
J.-P. Delplanque, X. Fang, P. Givi, O.Icoz, M. Masoudi, K. Molavi,
G. Patnaik, T. Pham, S. Prakash, G. Riva, D.N. Schiller, S. Stanchi,
B. Strayer , A.Y. Tong, S. Yalamanchili**

**Funding Organizations -- AFOSR, ARO, DOE, NASA, NSF, ONR,
Societe Europeenne de Propulsion , California Energy Commission**

Help with PowerPoint -- J. A. Sirignano